

## Interactive Catalog Replaces Catalog Pages

Honeywell Sensing and Control has replaced the PDF product catalog with the new **Interactive Catalog**. The **Interactive Catalog** is a power search tool that makes it easier to find product information. It includes more installation, application, and technical information than ever before.



**Click this icon to try the new  
Interactive Catalog.**

---

**Sensing and Control**  
Honeywell Inc.  
11 West Spring Street  
Freeport, Illinois 61032





### CUTAWAY V7 MINIATURE BASIC SWITCH

Thermoplastic material meets KC 250 arc tracking test per VDC 0630, DIN 53 480, and UL94V-0.

Mounting hole size options for #4 or 3mm screw.

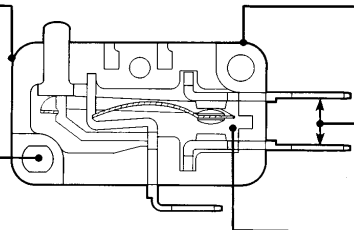

4mm (min) spacing between current carrying parts and mounting hardware.

"E" terminals designed to provide 3mm (min.) spacing with uninsulated receptacles installed. Terminals meet DIN 46 244 dimensions.

Internal construction meet 3mm (min.) creepage and clearance requirement.

### FEATURES

- Quick-connect and printed wiring board termination
- Proven V3 switching mechanism
- Physically interchangeable with existing V3 switches
- All existing V3 lever options available
- UL recognized File # E12252; CSA certified File # LR41370
- International listings carry VDE approval
- Power load switching capability up to 21 amps
- Temperature tolerance -40° to 185°F (-40° to 85°C)
- High temperature construction available—350°F

### APPLICABLE EUROPEAN SYMBOLS

- μ = microgap construction. (The measurement between open contacts is less than 3mm).\*\*
- ~ = alternating current (used with value of voltage source: 250V ~).
- T = maximum rated use temperature; followed by the temperature value in °C (example T 85).
- +++ = switch is rated for at least 50,000 cycles at its rated current. (Sometimes referred to as "frequent" operation.)
- 10(3) = first number represents resistive rating. Second number represents inductive (motor) rating.

### GENERAL INFORMATION

The V7 Series is available in two versions, the Timesaver series and the International series. The Timesaver series is UL recognized and CSA certified. Timesaver series switches use readily available high-volume components to provide especially responsive delivery performance. The International V7 provides VDE approval in addition to UL recognition and CSA certification.

The V7 offers a choice of four quick-connect and two printed wiring board terminal types. Three quick-connect types are offset to meet international 3mm spacing requirements and one is designed for use with molded connectors. Contact material choice includes gold alloy, silver alloy or silver for handling various electrical loads. There are two mounting hole sizes available. Standard .114" or 3mm to meet European design requirements.

Terminal variations and switch dimensions of the European designed version conform to applicable DIN standards. These V7s mate with both standard domestic and international industry stan-

dard receptacles and connectors. The plastic enclosure meets VDE KC250 arc tracking requirement and is approvable under the Refrigeration Industry Taste and Odor test.

### OPERATING FORCES

- 175 grams (V rating only)
- 150 grams (Not applicable to Electrical Rating V)
- 75 grams (Not applicable to Electrical Rating C or V)
- 50 grams (Not applicable to Electrical Rating B, C, V)
- 25 grams (Not applicable to Electrical Rating B, C, E, V)
- 15 grams (Not applicable to Electrical Rating A, B, C, E, S, V)

Mounting Torque:  
2 inch pounds min.  
5 inch pounds max.

### ELECTRICAL RATINGS

A	B	C*	D	E	F	S	V
5 amps, 125, 250 or 277 VAC; 1/10 hp, 250 VAC	11 amps and 1/8 hp, 125, 250 or 277 VAC; 1/2 amp, 125 VDC; 1/4 amp, 250 VDC; 4 amps, 125 VAC "L"	15.1 amps and 1/2 hp, 125, 250 or 277 VAC; 1/2 amp, 125 VDC; 1/4 amp, 250 VDC; 5 amps, 120 VAC "L"	1 amp, 125 VAC	10 amps and 1/8 hp, 125 or 250 VAC; 1/2 amp, 125 VDC; 1/4 amp, 250 VDC; 4 amps, 125 VAC "L"	3 amps, 125, 250 or 277 VAC; 1/10 hp, 250 VAC	.1 amp, 125 VAC	21 amps 125, 250 or 277 VAC, 1 HP 125, 250, 277 VAC; 2 HP, 250, 277 VAC
W	X						
15.1 amps, 125, 250 or 277 VAC	6 amps; 1/8 HP, 125, 250 or 277 VAC						
International Series Only							
10 (3) +++ 250V ~ T 85 μ			5 (2) +++ 250V ~ T 85 μ			+++	16 (4) 250V ~ T 85 μ 50E3 SPNO only

\* Available only when specifying 150 gram operating force.  
NOTE: "L" denotes lamp load.

\*\* The microgap construction (M) means contact gap is less than 3mm. Therefore, these products are suitable for secondary circuit use but not primary circuit use which requires a 3mm gap.

# Basic Switches

## Miniature

V7 Series

### AVAILABLE TERMINALS

#### Quick-connect

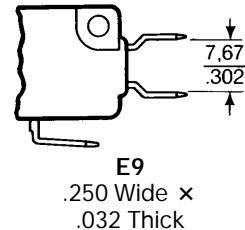
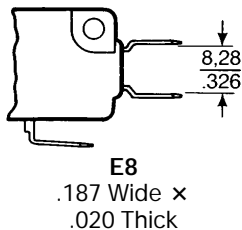
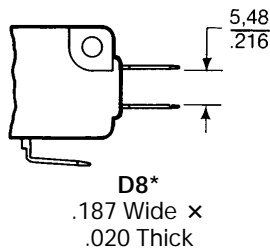

NOTE: D8 and E8 terminals are European approved when used with electrical ratings B, D, or E. E9 terminals are European approved when used with electrical ratings B, C, D, or E.

\* International approving agencies will require that switches with these terminals have insulated receptacles or connector.

### Printed Wiring Board

Printed wiring board terminals interface with snap-on receptacles and other components from AMPMODU interconnection system.

Dimensions shown are for reference only.

Key:  $\frac{0,0}{0.00} = \text{mm}$   
 $\frac{0.00}{0.00} = \text{inches}$

#### PO1

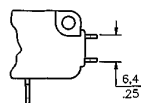
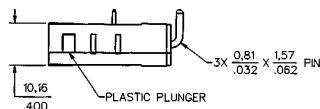
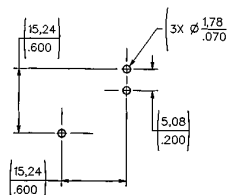

#### PO2

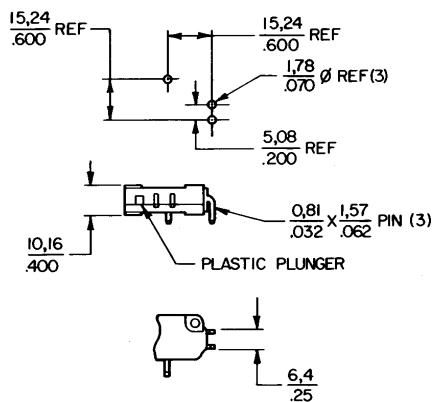

#### PO7

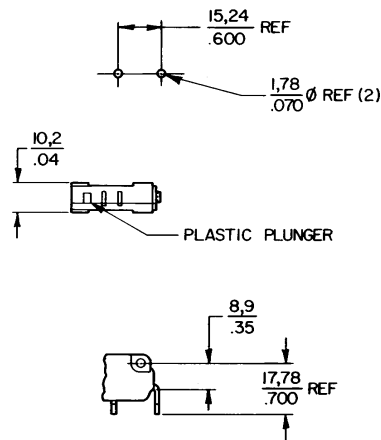

Miniature/  
Subminiature

This section covers only 48 of our most popular V7 Series catalog listings. If you don't find what you're looking for, it's likely one of the approximately 300 other active V7 listings will meet your needs. Contact the 800 number.

# Basic Switches

## Miniature

# V7 Series

### TIMERSAVER SERIES

#### PIN PLUNGERS



Dim. Dwg. Fig. 1

#### ORDER GUIDE - SPDT\*

Characteristics: O.F. – Operating Force; R.F. – Release Force; P.T. – Pretravel; O.T. – Overtravel; D.T. – Differential Travel.

Catalog Listing	Elect. Rating P. 38	O.F. max. grams ounces	R.F. min. grams ounces	P.T. max. mm inches	O.T. min. mm inches	D.T. mm inches
V7-1S17D8	1 Amp S	150 5.3	25 .88	1,19 .047	1,27 .050	0,05-0,25 .002-.010
V7-3S17E9	1 Amp S	50 1.75	5 .175	1,19 .047	1,27 .050	0,05-0,25 .002-.010
V7-3A17E9	5 Amps A	50 1.75	5 .175	1,19 .047	1,27 .050	0,05-0,25 .002-.010
V7-2B17D8	11 Amps B	75 2.63	10 .35	1,19 .047	1,27 .050	0,05-0,25 .002-.010
V7-2B17E9	11 Amps B	75 2.63	10 .35	1,19 .047	1,27 .050	0,05-0,25 .002-.010
V7-1C17D8	15.1 Amps C	150 5.3	25 .88	1,19 .047	1,27 .050	0,05-0,25 .002-.010
V7-9W1AE9	15.1 Amps W (350°F)	300 10.6	25 .88	1,19 .047	1,27 .050	0,25 .010 max.
V7-1V19E9	21 Amps V	175 6.1	20 .70	1,19 .047	1,27 .050	0,05-0,25 .002-.010

#### STRAIGHT LEVERS



Dim. Dwg. Fig. 2

#### ORDER GUIDE - SPDT\* .87" LEVER TIMESAVER SERIES

V7-3S17D8-002	1 Amp S	54 1.9	3 .11	1,52 .060	0,89 .035	0,33 .013
V7-1A17D8-002	5 Amps A	160 5.6	7 .25	1,52 .060	0,89 .035	0,38 .015
V7-2B17D8-002	11 Amps B	80 2.8	5 1.76	1,52 .060	0,89 .035	0,38 .015
V7-1C17E9-002	15.1 Amps C	160 5.6	17 .60	1,52 .060	0,89 .35	0,36 .014
V7-1V19E9-002	21 Amps V	185 6.5	13 .5	1,65 .065	0,89 .035	0,38 .015

#### 1.40" LEVER TIMESAVER SERIES

V7-3S17D8-022	1 Amp S	30 1.05	1 0.035	3,04 .120	2,16 .085	0,76 .030
V7-1A17E9-022	5 Amps A	85 3	8 .28	3,04 .120	1,52 .060	0,76 .030
V7-1X2AD8-022	6 Amps X (350°F)	185 6.5	15 .53	1,40 .055	0,76 .030	0,38 .015
V7-1B17D8-022	11 Amps B	82 2.9	8 .28	3,04 .120	1,7 .067	0,68 .027
V7-1C17E9-022	15.1 Amps C	82 2.9	8 .28	3,04 .120	1,7 .067	0,76 .030
V7-1V19E9-022	21 Amps V	95 3.3	5 .18	3,3 .130	1,78 .070	0,76 .030

#### 2.34" LEVER TIMESAVER SERIES

V7-3S17D8-048	1 Amp S	16 .56	.5 .018	5,97 .235	3,0 .118	1,27 .050
V7-2B17D8-048	11 Amps B	20 .7	1 .035	5,97 .235	2,92 .115	1,27 .050
V7-1C17E9-048	15.1 Amps C	85 3	4 .14	5,97 .235	1,65 .065	1,29 .051
V7-9W1AE9-048	15.1 Amps W (350°F)	90 3.2	4 .14	6,35 .250	3,15 .124	1,37 .054

\* For SPST (N.O. & N.C.) circuitry, contact the 800 number.

NOTE: Catalog listings in V7 Order Guides have standard .114" mounting holes. For 3mm size holes, contact the 800 number.

# Basic Switches

## Miniature

# V7 Series

### SIMULATED ROLLER LEVERS

### ORDER GUIDE - SPDT\* 1.29" LEVER TIMESAVER SERIES

Characteristics: O.F. – Operating Force; R.F. – Release Force; P.T. – Pretravel; O.T. – Overtravel; D.T. – Differential Travel.

Catalog Listing	Elect. Rating P. 38	O.F. max. grams ounces	R.F. min. grams ounces	P.T. max. mm inches	O.T. min. mm inches	D.T. max. mm inches
-----------------	---------------------	------------------------	------------------------	---------------------	---------------------	---------------------

### 1.29" LEVER TIMESAVER SERIES

V7-1S17D8-263	1 Amp S	90 3.15	9 .32	2,79 .110	1,9 .075	0,76 .030
V7-1B17D8-263	11 Amps B	90 3.15	9 .32	2,79 .110	1,52 .060	0,76 .030
V7-1C17D8-263	15.1 Amps C	91 3.19	9 .32	2,79 .110	1,54 .061	0,61 .024

### .81" ROLLER LEVER TIMESAVER SERIES

V7-2S17D8-201	1 Amp S	90 3.15	7 .25	1,19 .047	1,02 .040	0,38 .015
V7-2B17D8-201	11 Amps B	88 3.1	7 .25	1,3 .052	1,04 .041	0,3 .012
V7-1C17E9-201	15.1 Amps C	176 6.16	19 .67	1,3 .052	0,81 .032	0,3 .012
V7-1V19E9-201	21 Amps V	205 7.2	15 .5	1,42 .056	0,81 .032	0,33 .013

### 1.34" ROLLER LEVER TIMESAVER SERIES

V7-3S17D8-207	1 Amp S	35 1.23	2 .07	2,79 .110	2,03 .080	0,76 .030
V7-2A17D8-207	5 Amps A	43 1.51	3 .105	2,92 .115	1,52 .060	0,64 .025
V7-1C17E9-207	15.1 Amps C	86 3	9 .32	2,84 .112	1,63 .064	0,64 .025
V7-1V19E9-207	21 Amps V	100 3.5	7 .25	3,07 .121	1,65 .065	0,76 .030

\* For SPST (N.O. & N.C.) circuitry, contact the 800 number.

NOTE: Catalog listing in V7 Order Guides have standard .114" mounting holes. For 3mm size holes, contact the 800 number.



Dim. Dwg. Fig. 3



Dim. Dwg. Fig. 4





Dim. Dwg. Fig. 7

Miniature/  
Subminiature

Key:  $\frac{0,0}{0.00} = \frac{\text{mm}}{\text{inches}}$

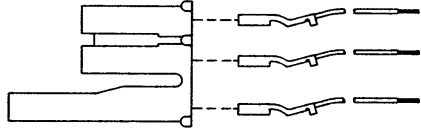
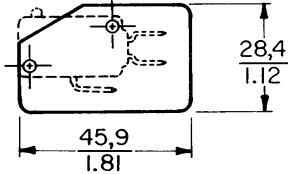
### ORDER GUIDE – ACCESSORIES

Catalog Listing	Description	Catalog Listing	Description
15PA176-V7	Connector/Receptacle packet - Includes 25 connectors and 75 receptacles with 18", blue 16 gauge PVC insulated, stranded wire. (To be used with D8 terminals only). 	15PA177-V7	Insulator packet (500 pcs.) .018" thick varnished fiberglass. 
15PA260	Plunger boot seal. Elastomer dust and splash resistant plunger seal. 		

Dimensions shown are for reference only.

# Basic Switches

## Miniature

# V7 Series

### INTERNATIONAL SERIES

#### PIN PLUNGER



Dim. Dwg. Fig. 1

#### ORDER GUIDE - SPDT\* INTERNATIONAL SERIES

**Characteristics:** O.F. – Operating Force; R.F. – Release Force; P.T. – Pretravel; O.T. – Overtravel; D.T. – Differential Travel.

Catalog Listing	Elect. Rating P. 38	O.F. max. grams ounces	R.F. min. grams ounces	P.T. max. mm inches	O.T. min. mm inches	D.T. mm inches
V7-1B11E9	11 Amps B	150 5.3	25 .88	1,19 .047	1,27 .050	0,05-0,25 .002-.010
V7-2B11D8	11 Amps B	75 2.63	10 .35	1,19 .047	1,27 .050	0,05-0,25 .002-.010
V7-2B11PO2	11 Amps B	75 2.63	10 .35	1,19 .047	1,27 .050	0,05-0,25 .002-.010
V7-3E11D8	10 Amps E	50 1.75	5 .175	1,19 .047	1,27 .050	0,05-0,25 .002-.010
V7-3E11E9	10 Amps E	50 1.75	5 .175	1,19 .047	1,27 .050	0,05-0,25 .002-.010

#### STRAIGHT LEVERS



Dim. Dwg. Fig. 5

#### 1.40" LEVER INTERNATIONAL SERIES

V7-1B11E9-022	11 Amps B	80 2.8	8 .28	2,79 .110	2,28 .090	0,76 .030
V7-2B11E9-022	11 Amps B	45 1.58	4 .14	2,79 .110	2,28 .090	0,76 .030
V7-3E11D8-022	10 Amps E	30 1.05	2 .070	2,79 .110	2,28 .090	0,76 .030

#### SIMULATED ROLLER LEVERS



Dim. Dwg. Fig. 3

#### 1.29" LEVER INTERNATIONAL SERIES

V7-2B11D8-263	11 Amps B	50 1.75	5 .175	2,54 .100	1,9 .075	0,76 .030
V7-3E11E9-263	10 Amps E	33 1.16	2 .070	2,54 .100	1,9 .075	0,76 .030

#### ROLLER LEVERS



Dim. Dwg. Fig. 4

#### ORDER GUIDE - SPDT\* .81" LEVER INTERNATIONAL SERIES

V7-2B11D8-201	11 Amps B	90 3.15	10 .35	1,19 .047	1,02 .040	0,38 .015
V7-3E11D8-201	10 Amps E	62 2.17	5 .175	1,19 .047	1,02 .040	0,38 .015

#### 1.34" LEVER INTERNATIONAL SERIES

V7-2B11E9-207	11 Amps B	45 1.58	5 .175	2,54 .100	2,16 .085	0,76 .030
---------------	--------------	------------	-----------	--------------	--------------	--------------

NOTE: Catalog listings in V7 Order Guides have standard .114" mounting holes. For 3mm size holes, contact the 800 number.



Dim. Dwg. Fig. 7

# Basic Switches

## Miniature

V7 Series

### MOUNTING DIMENSIONS (for reference only)

Key:  $\frac{0,0}{0.00} = \text{mm}$   
 $\frac{0,00}{0.00} = \text{inches}$

### PIN PLUNGER

Fig. 1

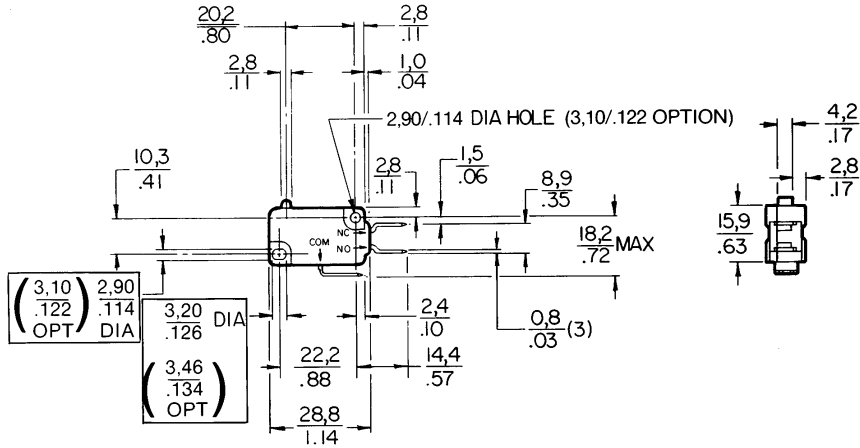
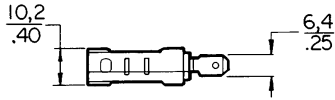

Miniature/  
Subminiature

Fig. 2 Straight Lever (Style-002)

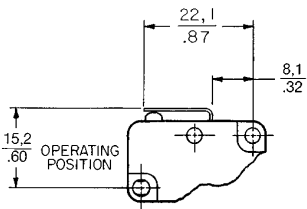

Fig. 3 Simulated Roller (Style-263)

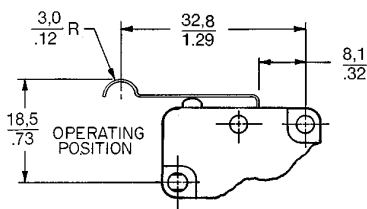

Fig. 4 Roller Lever (Style-201)

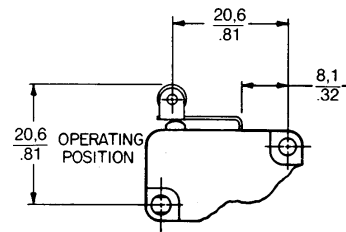

Fig. 5 Straight Lever (Style-022)

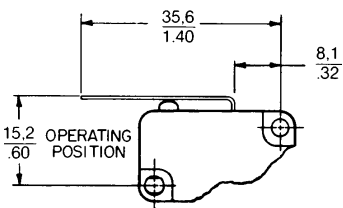

Fig. 6 Straight Lever (Style-048)

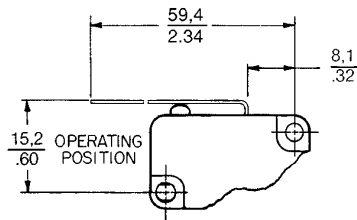
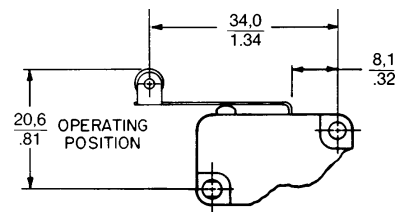

Fig. 7 Roller Lever (Style-207)



NOTE: All levers are 0.17" (4,31 mm) wide. Rollers are 0.19" (4,82 mm) wide.

NOTE: Operate point dimensions taken at top of lever/roller.