

## Interactive Catalog Supplements Catalog PDFs

If you need detailed product information, or help choosing the right product for your application, see our **Interactive Catalog**. Use the **Interactive Catalog** to access the most complete and up-to-date information available.

The **Interactive Catalog** provides an extensive collection of product specifications, application data, and technical literature that can be searched based on criteria you select.

This PDF catalog information was published in November 2000.



Sensing and Control  
**Interactive  
Catalog...**

**Click this icon to try  
the Interactive Catalog.**

**Sensing and Control**  
Honeywell Inc.  
11 West Spring Street  
Freeport, IL 61032



# Manual Switches

## Toggle Switch Assemblies



Standard lever

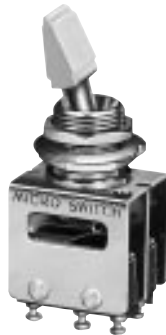

Tab lever



Pull-to-unlock lever

### FEATURES

- 2 or 3-position, momentary and maintained action.
- 2, 3 or 4 SPDT precision basic switches.
- Standard toggle, tab, or pull-to-unlock levers.
- Silver or gold contacts.
- <sup>15</sup>/<sub>32</sub>-inch bushing.
- UL recognized, CSA certified basic switches.
- Lever-to-bushing seal option.

### ELECTRICAL RATINGS — Basic Switches

	UL/CSA Rating	Load	30 VDC Rating	
			Amps	
			Sea Level	50,000 ft.
Silver Contacts	5 amps, 125-250 VAC	Inductive Resistive Max. Inrush	3 5 24	2.5 5 24
Gold Contacts	1 amp, 125 VAC	Inductive Resistive Max. Inrush	0.5 1 2	0.5 1 2

### PULL-TO-UNLOCK TOGGLE LEVERS

As a guard against accidental operation, pull-to-unlock toggle levers must be pulled .090 inch/2,3 mm (approx.) to change positions. A chart showing the 13 locking configurations and their catalog listing suffix code letters is shown on the following page.

### TERMINALS

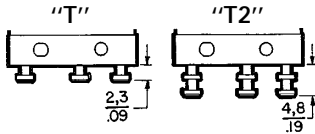

### AT 2-POSITION ORDER GUIDE

Toggle Lever Position		No. of Poles/ Switches	Type Contacts	Standard Lever "T"			Tab Lever "T2"	Pull-To-Unlock Lever Solder Terminals (Add locking letter to catalog listings below)			
Keyway	Opposite Keyway			Solder Terminals	Terminals	"T2" Terminals	Terminals				
Maint.	Maint.	2	Silver	23AT1	23AT1-T	23AT1-T2	23AT402-T2	23AT1-	Locking letters: D, F, or G		
			Gold	23AT11		23AT11-T2		23AT11-			
		3	Silver	23AT2	23AT2-T	23AT2-T2		23AT2-			
			Gold	23AT12		23AT12-T2		23AT12-			
		4	Silver	23AT3	23AT3-T	23AT3-T2		23AT3-			
			Gold	23AT8							
		Mom.	Maint.	2	Silver	23AT4	23AT4-T	23AT4-T2		23AT403-T2	
					Gold	23AT19					
3	Silver			23AT5							
	Gold										
4	Silver			23AT6		23AT6-T2					
	Gold										

### AT MIL-S-8805/26 VERSIONS ORDER GUIDE

Toggle Lever Position		No. of Poles/ Switches	Type Contacts	Standard Lever "T2" Terminals		Tab Lever "T2" Terminals	
Keyway	Opposite Keyway			Catalog Listing	Military No.	Catalog Listing	Military No.
Maint.	Maint.	2	Silver	23AT73-T2	M8805/26-001	23AT473-T2	M8805/26-003
		4	Silver	23AT74-T2	M8805/26-002	23AT474-T2	M8805/26-004

Manuals

# Manual Switches

## Toggle Switch Assemblies

13T Series

### AT 3-POSITION ORDER GUIDE

Toggle Lever Position			No. of Poles/ Switches	Type Contacts	Standard Lever			Tab Lever "T2" Terminals	Pull-To-Unlock Lever Solder Terminals (Add locking letter to cat. listings below)		
Keyway	Center	Opposite Keyway			Solder Terminals	"T" Terminals	"T2" Terminals				
Maint.	Maint.	Maint.	2	Silver	13AT2	13AT2-T	13AT2-T2	13AT402-T2	Locking letters: All types		
				Gold	13AT18	13AT18-T					
			3	Silver	13AT5			13AT5-			
				4	Silver	13AT9		13AT9-T2		13AT409-T2	13AT9-
					Gold	13AT29					
Mom.	Maint.	Mom.	2	Silver	13AT1	13AT1-T	13AT1-T2	13AT401-T2	Locking letters: E, L, or N		
				Gold	13AT26			13AT423-T2			
			3	Silver	13AT4			13AT413-T2			
				4	Silver	13AT8		13AT8-T2			13AT8-
					Gold						
Maint.	Maint.	Mom.	2	Silver	13AT3	13AT3-T	13AT3-T2	13AT403-T2	Locking letters: E, G, B, L, P or N		
				Gold							
			4	Silver	13AT10			13AT410-T2		13AT10-	

### AT MIL-S-8805/26 VERSIONS ORDER GUIDE

Toggle Lever Position			No. of Poles/ Switches	Type Contacts	Standard Lever "T2" Terminals		Tab Lever "T2" Terminals	
Keyway	Center	Opposite Keyway			Catalog Listing	Military No.	Catalog Listing	Military No.
Mom.	Maint.	Mom.	2	Silver	13AT271-T2	M8805/26-005	13AT471-T2	M8805/26-006
			3	Silver			13AT474-T2	M8805/26-012
Maint.	Maint.	Maint.	2	Silver	13AT272-T2	M8805/26-007	13AT472-T2	M8805/26-008
			3	Silver	13AT275-T2	M8805/26-013		
Maint.	Maint.	Mom.	2	Silver	13AT273-T2	M8805/26-009	13AT473-T2	M8805/26-010

#### LEVER-TO-BUSHING SEAL OPTION

A splash type lever-to-bushing seal can be provided to help prevent the entrance of moisture and dust behind the panel, or into the contact area.

#### HERMETICALLY SEALED BASIC SWITCH OPTION













AT's with <sup>15</sup>/<sub>32</sub>" bushings can be furnished with HM or HS hermetically sealed basic switches, which have metal-to-metal fusion around the cover, actuator base and mounting holes. Terminals are sealed glass-to-metal. For more information, contact your MICRO SWITCH Sales Office.



Shown with HM basic switches

#### LOCKING CONFIGURATIONS

When ordering pull-to-unlock toggle listings, add the suffix letter shown in this chart to the standard toggle catalog listing and the Military Approval number.

<b>A</b>  Locked In Three Positions	<b>B</b>  Locked In Center and Extreme Position (Keyway Side)	<b>D</b>  Locked Out Of Center Position	<b>E</b>  Locked In Center Position	<b>F</b>  Locked In Extreme Position (Opposite Keyway)	<b>G</b>  Locked In Extreme Position (Keyway Side)	<b>H</b>  Locked Out Of Center And Extreme Position (Keyway Side)
<b>J</b>  Locked Out Of Center And Extreme Position (Opposite Keyway)	<b>K</b>  Locked In Center And Extreme Position (Opposite Keyway)	<b>L</b>  Locked Out Of Extreme Position (Keyway Side)	<b>M</b>  Locked Out Of And Into Extreme Position (Opposite Keyway)	<b>N</b>  Locked Out Of Extreme Position (Opposite Keyway)	<b>P</b>  Locked Out Of And Into Extreme Position (Keyway Side)	

# Manual Switches

## Toggle Switch Assemblies

60AT Series



Standard lever



Pull-to-unlock lever

### FEATURES

- Compact multi-pole design conserves space and weight
- 2, 4, 6, or 8 SPDT precision basic switches
- 2 or 3-position, momentary and maintained action
- 15/32" bushing
- Standard or pull-to-unlock toggle levers
- MIL-S-8805/98 qualified versions

### PULL-TO-UNLOCK OPTION

As a guard against accidental operation, pull-to-unlock levers must be pulled .090 in./2,3 mm (approx.) to change positions. See chart on facing page which shows locking configurations and locking letter suffix codes which are referred to in the order guides.

Note: To order replacements for the resilient white caps which are screwed onto 60AT locking levers, specify Catalog Listing **15PA90-6W**.

**C** = common, **NC** = normally closed, **NO** = normally open.  
**Numbers** = basic switch designations.

### ELECTRICAL RATINGS — Basic Switches (in amperes)

Load	Sea Level			50,000 Ft.		
	28 VDC	115 VAC* 400 Hz	250 VAC 60 Hz	28 VDC	115 VAC* 400 Hz	250 VAC 60 Hz
Resistive	7	7	7	7	7	7
Inductive	4**	7	7	2.5**	7	7
Motor	4	3.3	3.3	4	3.3	3.3
Lamp	2.5	2	2	2.5	2	2

Inrush: 20 amps

\* 75% power factor.

\*\* Use AN31796 inductor.

### AT 2-POSITION ORDER GUIDE

No. of Poles/ Switches	Circuits Made With Toggle At:				Standard Lever Catalog Listing		Pull-To-Unlock Lever Suffix (Add locking letter to cat. listings)
	Keyway Position		Opposite Keyway		With MIL-S-6743 Basic Switches	With MIL-S-8805/4 Basic Switches	
	C-NC	C-NO	C-NC	C-NO			
2	1, 2 1, 2*	— —	— —	1, 2 1, 2*	62AT11-3 62AT11-8 62AT11-82	62AT22-3 62AT22-8 62AT22-82	D, G F G
4	1, 2	3, 4	3, 4	1, 2	64AT11-3	64AT22-3	D, F, G
6	1, 2, 3	4, 5, 6	4, 5, 6	1, 2, 3	66AT11-3	66AT22-3	D, F, G
8	1, 2, 3, 4	5, 6, 7, 8	5, 6, 7, 8	1, 2, 3, 4	68AT11-3	68AT22-3	D, F, G

### AT MIL-S-8805/98 VERSIONS (WITH BUSHING AND PANEL SEALS) ORDER GUIDE

No. of Poles/ Switches	Circuits Made With Toggle At:				Standard Lever Version	
	Keyway Position		Opposite Keyway		Catalog Listing	Military No.
	C-NC	C-NO	C-NC	C-NO		
4	1, 2	3, 4	3, 4	1, 2	64AT300-3	M8805/98-015
6	1, 2, 3	4, 5, 6	4, 5, 6	1, 2, 3	66AT300-3	M8805/98-046
8	1, 2, 3, 4	5, 6, 7, 8	5, 6, 7, 8	1, 2, 3, 4	68AT300-3	M8805/98/077

\* Momentary positions. All others are maintained.

Manuals

# Manual Switches

## Toggle Switch Assemblies

60AT Series

### 60AT SERIES 3-POSITION ORDER GUIDE

C = common, NC = normally closed, NO = normally open.  
Numbers = basic switch designations.

No. of Poles/ Switches	Circuits Made With Toggle At:						Standard Lever Catalog Listing		Pull-To-Unlock Lever Suffix (Add locking letter to cat. listings)
	Keyway Position		Center Position		Opposite Keyway		With MIL-S-6743 Basic Switches	With MIL-S-8805/4 Basic Switches	
	C-NC	C-NO	C-NC	C-NO	C-NC	C-NO			
2	1	2	1, 2	—	2	1	62AT11-1	62AT22-1	All Types
4	1, 2	3, 4	All	—	3, 4	1, 2	64AT11-1	64AT22-1	All Types
	1, 2	3, 4	All	—	3, 4*	1, 2*	64AT11-514	64AT22-514	B, E, G, L, N, P
	1, 2*	3, 4*	All	—	3, 4	1, 2	64AT11-5	64AT22-5	E, F, K, L, M, N
	1, 2*	3, 4*	All	—	3, 4*	1, 2*	64AT11-7	64AT22-7	E, L, N
6	1, 2, 3	4, 5, 6	All	—	4, 5, 6	1, 2, 3	66AT11-1	66AT22-1	All Types
	1, 2, 3*	4, 5, 6*	All	—	4, 5, 6	1, 2, 3	66AT11-5	66AT22-5	E, F, K, L, M, N
	1, 2, 3*	4, 5, 6*	All	—	4, 5, 6*	1, 2, 3*	66AT11-7	66AT22-7	E, L, N
	1, 2, 3	4, 5, 6	All	—	4, 5, 6*	1, 2, 3*	66AT22-514	66AT22-514	B, E, G, L, N, P
8	1, 2, 3, 4	5, 6, 7, 8	All	—	5, 6, 7, 8	1, 2, 3, 4	68AT11-1	68AT22-1	All Types
	1, 2, 3, 4*	5, 6, 7, 8*	All	—	5, 6, 7, 8	1, 2, 3, 4	68AT11-5	68AT22-5	E, F, K, L, M, N
	1, 2, 3, 4*	5, 6, 7, 8*	All	—	5, 6, 7, 8*	1, 2, 3, 4*	68AT11-7	68AT22-7	E, L, N
	1, 2, 3, 4	5, 6, 7, 8	All	—	5, 6, 7, 8*	1, 2, 3, 4*	68AT11-514	68AT22-514	B, E, G, L, N, P

### 60AT MIL-S-8805/98 Versions (With bushing and panel seals)

No. of Poles/ Switches	Circuits Made With Toggle At:						Standard Lever Version (Pull-to-unlocks listed below order guide)	
	Keyway Position		Center Position		Opposite Keyway		Catalog Listing	Military No.
	C-NC	C-NO	C-NC	C-NO	C-NC	C-NO		
4	1, 2	3, 4	All	—	3, 4	1, 2	64AT300-1	M8805/98-001
	1, 2*	3, 4*	All	—	3, 4	1, 2	64AT300-5	M8805/98-019
	1, 2*	3, 4*	All	—	3, 4*	1, 2*	64AT300-7	M8805/98-026
6	1, 2, 3	4, 5, 6	All	—	4, 5, 6	1, 2, 3	66AT300-1	M8805/98-032
	1, 2, 3*	4, 5, 6*	All	—	4, 5, 6	1, 2, 3	66AT300-5	M8805/98-050
	1, 2, 3*	4, 5, 6*	All	—	4, 5, 6*	1, 2, 3*	66AT300-7	M8805/98-057
8	1, 2, 3, 4	5, 6, 7, 8	All	—	5, 6, 7, 8	1, 2, 3, 4	68AT300-1	M8805/98-063
	1, 2, 3, 4*	5, 6, 7, 8*	All	—	5, 6, 7, 8	1, 2, 3, 4	68AT300-5	M8805/98-081
	1, 2, 3, 4*	5, 6, 7, 8*	All	—	5, 6, 7, 8*	1, 2, 3, 4*	68AT300-7	M8805/98-092

\* Momentary positions. All others are maintained.

### 60AT MIL-S-8805/98 Pull-to-Unlock Versions (With bushing and panel seals)

These switches have the same circuitry as their companion standard lever catalog listings in the MIL-S-8805/98 order guides. Example: 64AT300-1 has the same circuitry as 64AT300-1A. (Refer to locking chart on page 53.) Note: It is not necessary to add locking letter suffixes to M8805/98 military numbers.

Cat. Listing	Military No.	Cat. Listing	Military No.	Cat. Listing	Military No.	Cat. Listing	Military No.
64AT300-1A	M8805/98-002	64AT300-5M	M8805/98-024	66AT300-3F	M8805/98-048	68AT300-1K	M8805/98-072
-1B	-003	-5N	-025	-3G	-049	-1L	-073
-1D	-004	64AT300-7E	M8805/98-027	66AT300-5E	-051	-1M	-074
-1E	-005	-7L	-028	-5F	-052	-AN	-075
-1F	-006	-7N	-029	-5K	-053	-1P	-076
-1G	-007			-5L	-054	68AT300-3D	M8805/98-078
-1H	-008	66AT300-1A	M8805/98-033	-5M	-055	-3F	-079
-1J	-009	-1B	-034	-5N	-056	-3G	-080
-1K	-010	-1D	-035	66AT300-7E	M8805/98-058	68AT300-5E	-082
-1L	-011	-1E	-036	-7L	-059	-5F	-083
-1M	-012	-1F	-037	-7N	-060	-5K	-084
-1N	-013	-1G	-038			-5L	-085
-1P	-014	-1H	-039	68AT300-1A	M8805/98-064	-5M	-086
64AT300-3D	M8805/98-016	-1J	-040	-1B	-065	-5N	-087
-3F	-017	-1K	-041	-1D	-066	68AT300-7E	-089
-3G	-018	-1L	-042	-1E	-067	-7L	-090
64AT300-5E	M8805/98-020	-1M	-043	-1F	-068	-7N	-091
-5F	-021	-1N	-044	-1G	-069		
-5K	-022	-1P	-045	-1H	-070		
-5L	-023	66AT300-3D	M8805/98-047	-1J	-071		

# Manual Switches

## Toggle Switch Assemblies

AT Series

### MOUNTING DIMENSIONS (For reference only)

13/23AT

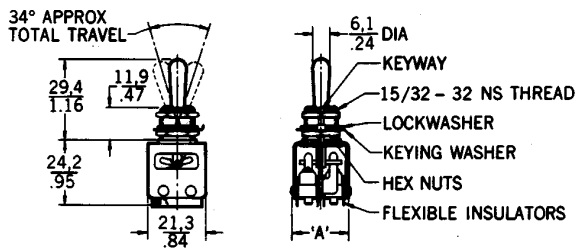

62AT

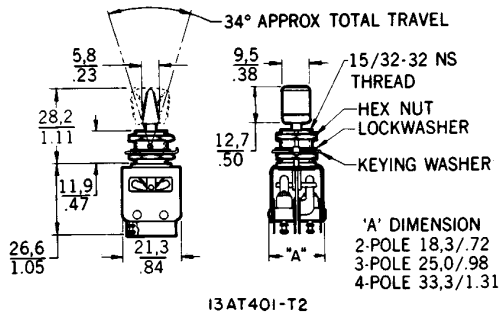
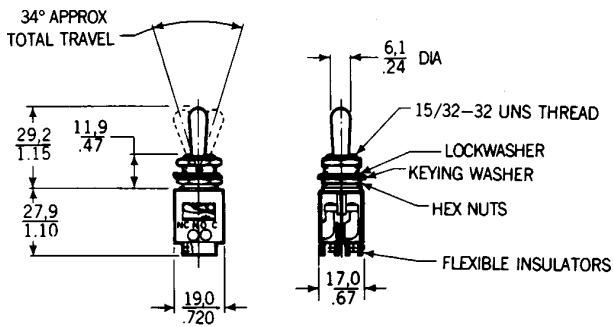

64/66/68AT

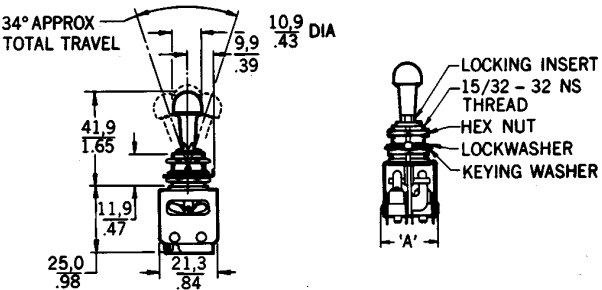
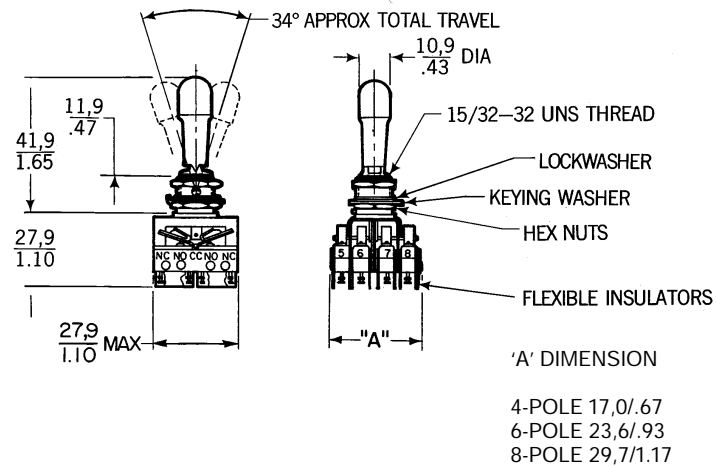

### PANEL CUTOUTS

1/4" Bushing

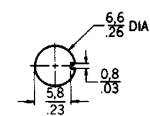

Without Locking Ring

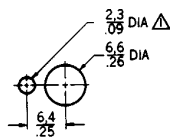

With Locking Ring

NOTE—  
△ 1.1/.05 MIN DEEP TO ACCOMMODATE LOCKING RING

1/2" Bushing

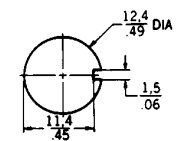

Without Locking Ring

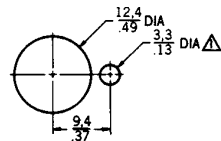

With Locking Ring

NOTE—  
△ 1.4/.06 MIN DEEP TO ACCOMMODATE LOCKING RING

NOTE—  
64AT300, 66AT300, and 68AT300 (M8805/98) listings have a bushing seal and MS25196 panel seal.

Manuals