

MICRO SWITCH General Technical Bulletin No. 14

APPLYING PRECISION SWITCHES

TABLE OF CONTENTS

INTRODUCTION.....1

BRIEF HISTORY OF THE PRECISION SWITCH.....1

I. THE MECHANICAL CHARACTERISTICS OF A PRECISION SWITCH.....5

 A. MECHANICAL ACTION AND TERMINOLOGY.....5

 B. THE RELATION BETWEEN PLUNGER FORCE AND PLUNGER POSITION.....6

 C. THE RELATION BETWEEN CONTACT FORCE AND PLUNGER POSITION.....8

 D. CONTACT BOUNCE AND TRANSIT TIME.....9

 E. POLES, THROWS AND BREAKS.....10

II. THE ELECTRICAL CHARACTERISTICS OF A PRECISION SWITCH.....11

 A. THE RESISTANCE OF AN OPEN SWITCH.....11

 B. CAPACITANCE OF AN OPEN SWITCH.....13

 C. SWITCHES AND RADIO FREQUENCY INTERFERENCE(RFI).....13

 D. THE RESISTANCE OF A CLOSED SWITCH.....14

III. SWITCH RESISTANCE15

 A. SOURCES OF SWITCH RESISTANCE16

 B. TYPICAL PATTERN AND MAGNITUDE OF SWITCH RESISTANCE.....16

 C. WHY SWITCH RESISTANCE BEHAVES AS IT DOES.....18

 D. THE ROLE OF CONTAMINATION IN SWITCH RESISTANCE.....19

 Solder Flux20

 Crushed Solids20

 Carbon20

 Polymer21

 Chemical Compounds of Contact Material and Foreign Material21

 Condensed Metal Vapor21

 Effect of Silicone on Electrical Contacts21

 Migration of Silicones22

 Wear Particles22

 E. CHOICES OF CONTACT MATERIAL.....22

 F. HOW SWITCH DESIGN AFFECTS RESISTANCE.....24

 G. HOW TO MEASURE SWITCH RESISTANCE.....25

 Voltage25

 Current25

 The Measuring Circuit.....26

 Switch Plunger Position26

 Sequence of Operations in Measuring Switch Resistance27

 H. WHEN TO GIVE SWITCH RESISTANCE SPECIAL ATTENTION.....27

 I. HOW TO BE CONSTRUCTIVELY CAUTIOUS ABOUT SWITCH RESISTANCE.....27

IV. STABILITY OF MECHANICAL OPERATING CHARACTERISTICS.....29

 A. NORMAL VARIATION OF OPERATING AND RELEASE POINT.....29

 B. HOW STABILITY IS AFFECTED BY FACTORS IN THE APPLICATION.....29

 Selection of the Switch.....29

 Mounting the Switch29

 Soldering Lead Wires to the Terminals30

 Actuation30

 Electrical Load30

 Summary of Facts About Operating and Release Point Versus Electrical Load.....32

 Acceleration, Vibration and Shock.....32

 Temperature and Humidity.....32

 Contamination32

 C. HOW TO STABILIZE OPERATING AND RELEASE POINT IN END USE.....32

V. SWITCH LIFE	34
A. THE NATURE OF SWITCH LIFE.....	34
Contact Welding	34
Contact Material Migration.....	35
Contact Erosion.....	35
Dielectric Breakdown.....	36
Mechanical Deterioration.....	36
B. THE EFFECTS OF CIRCUIT PARAMETERS ON SWITCH LIFE.....	36
The Current Rating of a Switch.....	36
Closing the Circuit	38
Carrying the Steady-State Current.....	38
Opening the Circuit.....	39
C. THE EFFECTS OF ACTUATION ON SWITCH LIFE.....	40
Direction of Actuation.....	40
Distance of Actuator Travel	41
Force Applied to Switch Plunger	41
Velocity of Actuating Member.....	41
Frequency of Switch Actuation.....	41
D. THE EFFECTS OF ENVIRONMENT ON SWITCH LIFE.....	42
E. EVALUATING AND ESTIMATING SWITCH LIFE.....	42
When are Life Tests Needed?.....	42
Control of Life Test Conditions	43
Switch Failure Criteria	44
Sample Size for Life Test.....	44
Combining Tests	44
Post Mortem Examination of the Switch.....	45
Interpretation of Life Test Results.....	45
F. HOW TO INCREASE SWITCH LIFE IN END USE.....	47
Electrical Factors.....	47
Mechanical Factors	48
Design of Cams for Switch Actuation.....	48
Environmental Factors	50
G. PREVENTIVE MAINTENANCE.....	50
VI. APPLYING SWITCHES IN HOSTILE ENVIRONMENTS.....	52
High Temperature	53
Low Temperature	53
Temperature Shock	53
Vacuum	53
High Pressure.....	53
Humidity	53
Liquid Splash or Shallow Immersion	53
Ice.....	53
Corrosion	53
Sand or Dust.....	53
Fungus.....	54
Explosion	54
A. ACCELERATION, SHOCK AND VIBRATION.....	54
B. ACOUSTIC EXCITATION.....	58
C. CORROSION	58
D. EXPLOSION.....	59
E. FUNGUS	60
F. HUMIDITY	60
G. ICE.....	60
H. LIQUID.....	61
I. HIGH PRESSURE	62
NEMA Standard Enclosure Types	63

J. LOW PRESSURE (VACUUM).....	63
Effects of Vacuum on Unsealed Switches.....	64
Reduction of Dielectric Strength.....	64
Reduction of Current Interrupting Ability.....	64
Increased Tendency of Contacts to Weld.....	65
Evaporation and Sublimation of Materials.....	65
K. NUCLEAR RADIATION.....	66
L. SAND OR DUST.....	66
M. HIGH TEMPERATURE.....	67
N. LOW TEMPERATURE.....	67
O. TEMPERATURE SHOCK.....	68
CONCLUSION.....	69
GLOSSARY OF SWITCH TERMS.....	70
INDEX.....	75

Introduction

In turning a circuit on or off, the average precision snap-acting switch changes its resistance by about 13 orders of magnitude in a couple of milliseconds, when its plunger moves about .001 inch. This same switch is able to control a 15 ampere, 240 volt heater, or the millivolt-milliamper circuit of a receiving antenna. Precision switches are designed to have, and maintain, uniform mechanical and electrical characteristics while controlling a wide variety of circuits in many different environments. Because of their versatility and small size, precision switches are used in an endless variety of equipment. They perform important functions in such diverse applications as production machinery, chicken brooders, submarines, computers, space vehicles, and medical instruments. When applied correctly, these switches perform well, and are a significant help in simplifying designs and reducing costs.

The application of precision switches is an intriguing technical subject. It draws upon many disciplines, including solid-state physics, plasma physics, physical chemistry, metallurgy, stress and vibration analysis, circuit analysis, and many others. Yet, it can be expressed in down-to-earth common-sense terms, and can be readily understood and applied without specialized background. The three aspects of switch use are mechanical, electrical, and environmental; each is covered in depth.

Although published by MICRO SWITCH, the information in this book applies to precision switches from all manufacturers.

Brief History of the Precision Switch

“A precision snap-acting switch is a mechanically operated electric switch having predetermined and accurately controlled characteristics, and having contacts other than the blade and jaw, or mercury type, where the maximum separation between any butting contacts is 1/8 inch. A precision snap - acting switch consists of a basic switch used alone, a basic switch used with actuator(s), or a basic switch used with actuator(s) and an enclosure” National Electrical Manufacturer’s Association.

Uncontrolled electricity was known in the Stone Age, but practical uses for this potent form of energy were not recognized until the late 18th Century. Even after Volta had developed a rechargeable battery and Faraday had perfected a generator capable of delivering continuous current, electricity was considered merely a laboratory curiosity. Early experimenters had little need for switches. To turn a circuit off they usually disconnected a wire from the battery. The better equipped experimenters achieved the same result by disengaging a clutch between the generator and the steam engine. But as practical uses were found for electricity, convenient means were needed for turning it on and off.

In the late 1700’s primitive telegraph systems included equipment for closing and opening the signal circuit. The first Morse telegraph of the 1830’s included a mechanically operated contact lever for this purpose, later replaced by a hand-operated contact lever or “key.” In some systems the key was provided with two contact pairs, one closed when the key was depressed, the other closed when the key was released (a double-throw switch).

The earliest power switches were simple hinged or cantilever beams, arranged to close and open a circuit. The blade-and-jaw knife switch with a wooden, slate or porcelain base and an insulated handle, evolved from these. By 1900, electric automobiles and street cars were in use, and by 1910, large electric motors were common. In at least one 1910 installation, the starting switch for a large motor consisted of two iron plates, a barrel of salt water and a rope (preferably dry) to lower one plate through the brine toward the other plate in the bottom of the barrel. The typical machine shop of the late 1920's and early 1930's had a steam engine or electric motor driving a line shaft from which pulleys and belts transmitted power to the individual machines. By 1930, many machines were equipped with individual electric motors. Switches were employed to turn the motor on and off, but any control beyond that point, such as the positioning of parts, relied heavily upon mechanical linkages.

Switches were becoming more widely used. Knife switches were common, and rotary selector or step switches were also coming into use. Key or doorbell push-button switches were used to control light electrical loads, while cock-and-fire devices were built to open circuits rapidly on heavier loads. The rotary wall switch with its porcelain base and black knob was succeeded by the two-button wall switch for control of room lights. Limit switches with butting contacts mounted on heavy arms were used to stop elevators and skip hoists. Float switches had contacts mounted on rocker arms connected to the float by a chain. Thermostats usually had a gas filled bellows or a two-metal linkage that carried a contact and controlled a relay. Pressure switches were characterized by a large diaphragm driving a toggle mechanism with a wide differential between operation and release. Automobiles used slide switches to control headlights and other circuits. There was no apparent need for mechanical precision in electrical switching. Or was there?

In 1927, H. G. Leupold, of the Scott Company in Boston, developed a snap-acting thermostatic switch. In 1932, a modification of the switch was incorporated in a temperature control developed by Scott for oil burner systems. The control differed from most thermostats in that it controlled the pump motor directly, at line voltage without the use of a relay.

It was at this time that Dr. Charles F. Burgess, owner of the C. F. Burgess Laboratories, Inc., of Madison, Wisconsin, saw the prototype of the Scott temperature control in an exhibit in Boston. (Dr. Burgess had been a Professor of Chemical Engineering at the University of Wisconsin, and started Burgess Battery Company, Freeport, Illinois.) Burgess formed the United Electric Controls Company, with a small factory in Boston. United Electric Controls secured a contract for the manufacture of 10,000 chicken brooders and ordered 10,000 switches from Scott for brooder temperature controls. However, the operating characteristics of the switch proved unstable, and an alternative switch had to be found. Unable to find the switch that he needed, and with imminent production deadlines, Burgess decided to make his own switch.

Dr. Burgess assigned the designing of a precise snap-acting switch mechanism to Philip K. ("Peter") McGall, a mechanic in the C. F. Burgess Laboratories in New York. He instructed McGall to develop a principle entirely different from that of the Scott switch. In 1932, McGall perfected a new switch mechanism. It was so successful that its principle is still used in most precision snap-acting switches today. The device was designed so that a very short travel of the switch plunger stored energy in a spring and used the energy to transfer the movable contact with a positive snap. McGall's design utilized the properties of heat treated beryllium copper, an excellent spring material and a good electrical conductor. The newly designed switch provided the stable operating characteristics required for the temperature control in the chicken brooder.

Fortunately, the application of precision switches were not limited to chicken brooders. A few of the newly designed switches were manufactured in New York during 1933. In September of 1933, operations were moved to Freeport, Illinois, and carried on as part of the Electronics Division of C. F. Burgess Laboratories. Space was rented from the Burgess Battery Company in Freeport. Meanwhile, McGall had refined the design of the switch, and in May 1934, a patent was granted. The precision switch business was launched and new uses for the switch were discovered. Most of these uses took advantage of the ability of the precision switch to maintain precise mechanical characteristics while controlling substantial electrical loads.

Patent drawing of the first practical precision snap-acting switch:

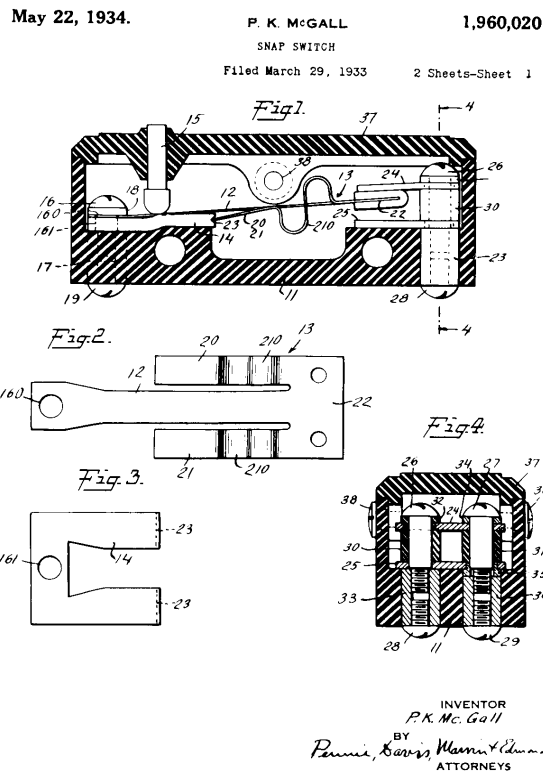

In 1934, Dr. Burgess brought Arthur L. Riche to Freeport as a consultant. Riche stayed to become General Manager of the C. F. Burgess Laboratories Electronic Division and guided the early growth of the switch business. In 1937, Dr. Burgess sold the Electronic Division to Walter B. Schulte, who had worked for him for 30 years. Schulte then divided his interests with Riche and Malcolm W. Eaton.

On March 1, 1937, the three men formed the MICRO SWITCH Corporation, with Schulte as president, Riche as vice president, and Eaton as secretary treasurer. They moved the plant to a new location in Freeport, and resumed operations with 37 employees. The national economy was in a precarious state and so was the company's financial position. At times, Schulte, Riche, and Eaton pooled their personal funds to meet the payroll. The new company's production equipment was primitive and temperamental. Problems were numerous and difficult. As with many small, struggling manufacturers, business was conducted with a degree of informality and lack of standardized procedure. A supervisor, conducting visiting dignitaries through the plant, opened the door of a drying oven to reveal a cheese sandwich toasting on the shelf. But despite setbacks, the business continued. Riche spent most of his time scouring the field looking for new switch applications and developing ways in which to meet their needs. Eaton worked on production problems and managed personnel and financial matters, under the administrative guidance of Schulte. As a result of a great deal of hard work by the company's employees, the precision switch "caught on."

The precision snap-acting switch was a fascinating new device. It greatly simplified designs, and remedied cost, weight and space problems. Complex mechanical linkages were replaced with a precision switch and a solenoid. Bulky switch gear often was replaced with a thumb-sized precision switch. Dimensions and movement in the order of .001 of an inch could be sensed rapidly and reliably without high force or wide differentials. As the precision switch gained popularity, new needs arose. Each new application presented a new combination of mechanical, electrical and environmental conditions, and resultant requirements for switch performance. Existing designs were modified to meet the requirements, and new designs were developed as needed. Lever and leaf actuators, as well as special plungers, permitted actuation of basic switches by cams and a wide variety of other linkages.

Industry was discovering the advantages of automatic and semi-automatic equipment, which required many precision switches. Most machines were now being equipped with individual motors, and special switches were developed to control the high-inrush motor loads. A magnetic blowout switch was designed with a permanent magnet straddling the contact gap to stretch and quench the arc of high voltage DC loads. A gauging switch was developed with special features as a dimension sensor. Switches were built with corrosion resistant springs, and others with metal housings for protection against contaminants. Sealed basic switches were developed for protection against dust. Splash-proof, and explosion-proof switches were designed, and special materials permitted the development of switches for use at high ambient temperature. When the need arose for switches to count coins in vending machines, a special line of low force coin switches were designed.

The precision switch proved to be extremely versatile and popular. Competitors began to enter the picture with switch designs, many of which bore a remarkable resemblance to those already on the market. However, they soon discovered that precision switches were not as simple as they appeared to design and manufacture, causing some to give up the attempt. Others survived, to produce first rate switches. Competition had a stimulating effect. In 1947, MICRO SWITCH brought out the subminiature switch, designed for applications where space and weight were at a premium, this was followed ten years later by the sub-subminiature switch that weighed one gram. MICRO SWITCH also developed the double-pole double-throw basic switch, the hermetically sealed precision switch, the ultra-high temperature precision switch and many others.

I. THE MECHANICAL CHARACTERISTICS OF A PRECISION SWITCH

Figure 1: Principal parts of a precision switch

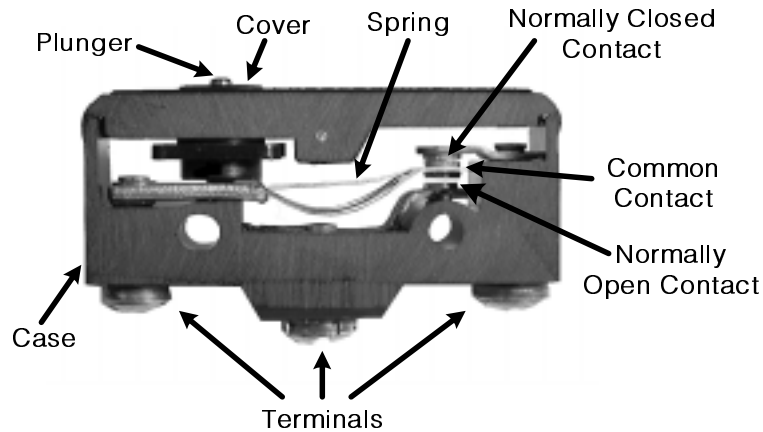

A. Mechanical action and terminology

Figure 1 illustrates a typical precision snap-acting switch. With the plunger in the completely released or *free position* (See **Figure 2**) the common contact is against the normally closed contact. In this condition, the normally closed circuit of the switch can carry current. In other words, there is electrical continuity between the common terminal and the normally closed terminal of the switch. The common terminal is electrically insulated from the normally open terminal. As the plunger is depressed, it reaches the *operating point*. The distance from the free position to the operating point is called the *pretravel*. At the operating point, without further movement of the plunger, the common contact accelerates away from the normally closed contact. Within a few milliseconds, the common contact strikes, bounces and comes to rest against the normally open contact. Because the mechanism is designed for “snap-action,” the common contact cannot stop part way between the normally closed and normally open contacts. The normally closed circuit is now open and the normally open circuit is closed. As the plunger is depressed farther, past the operating point, the normally open circuit remains closed and the normally closed circuit remains open.

Figure 2: Plunger movement characteristics of a basic switch

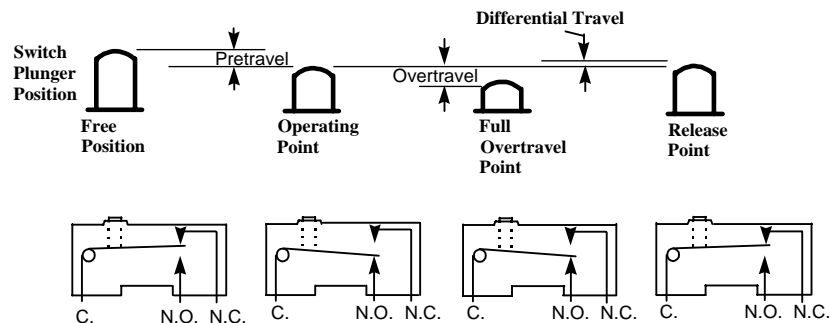

The distance the plunger travels past the operating point in this direction is called *overtravel*. When the plunger is fully depressed or at *full overtravel*, further depression of the plunger is prevented by the switch mechanism. The distance from the free position to the point of full overtravel is called the *total travel*. Total travel is the sum of the pretravel and overtravel. As the plunger is released from the point of full overtravel, it again passes the point at which the operating point has occurred, but this does not cause the position of the common contact to change. The normally open circuit remains closed and the normally closed circuit remains open until the plunger reaches the *release point*. At the release point, without further movement of the plunger, the common contact accelerates away from the normally open contact. Once more, within a few milliseconds the common contact strikes, bounces and comes to rest, this time against the normally closed contact. The normally open circuit is now open and the normally closed circuit is closed. This condition continues as the plunger is returned to the fully released or free position. The distance between the operating and release points is called the *differential travel*. The distance from the release point to the free position is called the *release travel*. As a rule, the essential points of plunger travel (free position, operating point, release point and full overtravel point) are measured and specified as dimensions from the center line of the mounting holes of the switch.

The force required to depress the plunger to the operating point is called the *operating force*. As the plunger is released from the operating point or from the overtravel region, the force required to hold the plunger at the release point is called the *release force*. The difference between the operating force and release force is called the *force differential* or differential force. These characteristics vary with the design of the switch and, to some extent, with its application. These will be discussed later.

In rotary-actuated precision switches, the operating characteristics are expressed in terms of the analogous angles of rotation and torques.

B. The relation between plunger force and plunger position

The force and travel characteristics of a precision snap-action switch can be most clearly represented on a graph of plunger force versus plunger position. The relation between these two variables is of particular interest to the designer when the switch is to be actuated by a force-sensitive device such as a dead weight, a thermostatic bimetal or a gas filled bellows. The shape and dimensions of the curve depend upon the design of the switch.

Figure 3 shows successive stages in the development of a curve of plunger force versus plunger position for a typical precision snap-acting switch. With no force on the plunger, the plunger is at its free position, designated Point A in **Figure 3**. First, observe the behavior of the force as the plunger is driven through its travel by means of a rigid device, such as a micrometer head. As the plunger is depressed, the force increases from zero. In this instance, the design of the switch is such that the force is a linear function of the travel and, when the two are plotted, the locus of points lies along Line AB. The vertical projection of Point B on the horizontal axis represents the operating point of the switch, while the horizontal projection of Point B on the vertical axis represents the operating force.

Figure 3: Plunger force versus plunger position

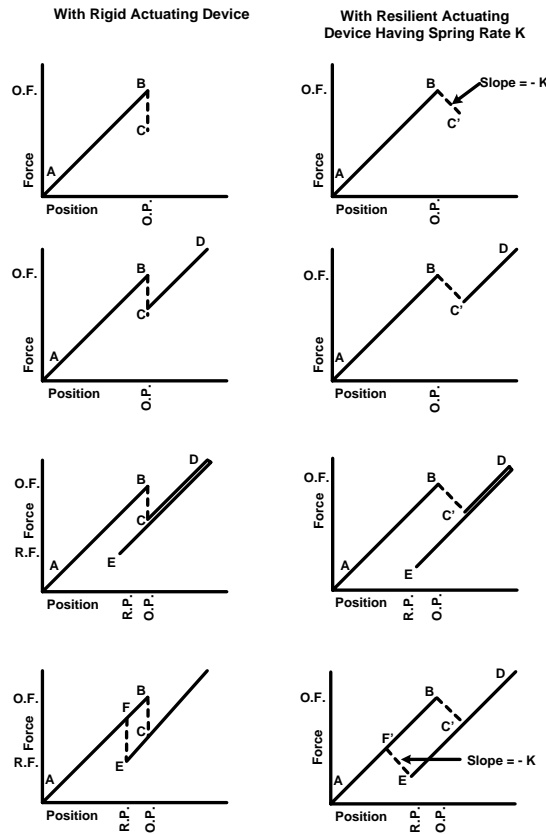

During travel of the plunger from A to B, mechanical energy is stored in the switch mechanism. When the plunger reaches the operating point, some of the stored energy is used by the switch mechanism to cause *snap-over* of the common contact from the normally closed to the normally open position. During snap-over, the plunger does not move from its position at Point B, because the actuating device is rigid, but the force applied to the actuating device by the plunger drops to the level represented by Point C. If the plunger is now moved into the overtravel range, the force will again increase, as shown by Line CD. Reversing the direction of plunger travel, and gradually releasing the plunger, the same line is retraced in the direction DC. However, the path continues in the same direction beyond Point C to Point E, the release point. At Point E, with no further movement of the plunger, the switch mechanism utilizes stored energy to snap back to its original position, and the force applied by the plunger rises to Point F on the graph.

Since the area under the curve ABCD represents the mechanical energy put into the switch, and the area under the curve DCEFA represents the energy returned by the switch to the actuating device, area BCEF represents the energy utilized by the switch mechanism in snapping over and back, as the plunger moves through the differential travel.

When a resilient actuating device is used, it merely changes the location of Points C and F. They are affected because the position of the actuating device is now determined by the varying force applied to it by the switch plunger. In this case, starting with the plunger at Point A, the resilient actuating device depresses the plunger with force varying linearly with travel, as shown by Line AB. At Point B, the operating point, the mechanism snaps over, but this time the plunger moves because it is held by a non-rigid device while the force is changing.

Instead of arriving at Point C, as it did with a rigid actuating device, the plunger arrives at Point C', the location of which is determined by the spring properties of the driving member.

Although path BC' is shown in **Figure 3** as a straight line, the path is not necessarily linear. As before, it is assumed to be linear for simplicity in this case, and is shown as a dashed line. Its actual shape usually is unimportant, but the location of C' can be of considerable interest to the designer. If the spring rate (force per unit of travel) of the resilient actuating device is K, draw a straight line with slope -K through Point B. Point C' then is located where this line intersects Line CD. In similar fashion, the release Point E remains unchanged; but after snap-back, the plunger is at Point F' instead of F. To locate Point F', draw a straight line with slope -K through Point E until it intersects Line AB.

C. The relation between contact force and plunger position

Contact force is the force holding closed contacts together. Contact force affects such diverse characteristics as electrical resistance and ability of the switch to maintain electrical continuity during acceleration, vibration, and shock. Switches usually are designed to have as high a contact force as possible, consistent with other requirements, and to maintain high contact force during as much of the plunger travel as possible. As a rule, contact force is not held at specified values during switch production, and the user gains nothing but unnecessary cost by specifying it. It is much wiser to specify the performance of the switch as a whole, rather than details of its internal design and adjustment.

Nevertheless, it is important for the switch user to know what is happening inside the switch, so it can be applied to get the best performance. It is relatively easy to design switch mechanisms having very high and constant contact force, regardless of plunger position, but this entails a wide differential travel and force differential, neither of which is desirable. In practice, therefore, a tradeoff is arranged in which contact force is maintained sufficiently high for good switch performance, without unduly wide differentials.

A graph may be used to show how contact force varies with plunger position. Since contact force (as we are using the term) has meaning only when the contacts are against each other, the graph usually is plotted as shown in **Figure 4**. The horizontal axis represents plunger travel, from free position to full overtravel, and shows the location of the operating and release points. The upper half of the vertical axis represents the force of the common contact against the normally closed contact of the switch, while the lower half represents the force of the common contact against the normally open contact. The graph shown in **Figure 4** is an instance in which the relation of contact force to plunger position is linear. In some switch mechanisms, the contact force curve is nearly horizontal, turning steeply downward as the plunger approaches the operating point, or upward as the plunger approaches the release point. The important fact is that, as the plunger approaches the operating or release point, contact force decreases and reaches zero at the instant when the contacts separate. With this in mind, one can visualize and understand switch behavior under several conditions which will be discussed later.

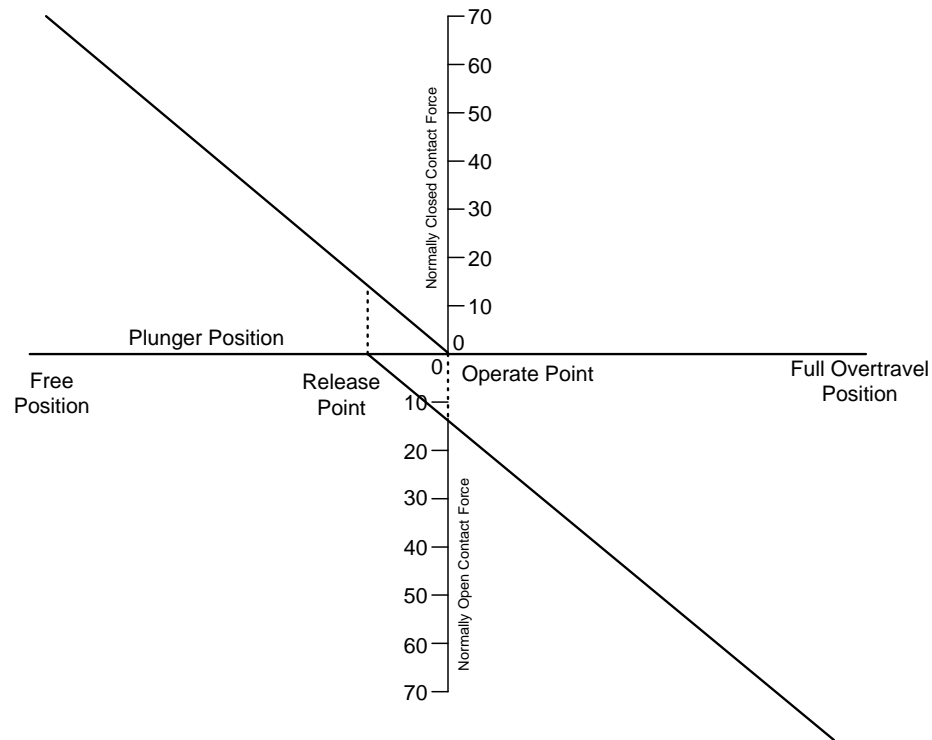
Figure 4: Contact force versus plunger position for typical switch

D. Contact bounce and transit time

Occasionally a switch application requires knowledge of contact transit time, or bounce time. These are best ascertained by measurement under the electrical and mechanical conditions of end use, but some background information may be helpful. The transit time is the time required for the moving contact to leave one stationary contact and strike the opposite stationary contact. When the moving contact strikes the stationary contact, the kinetic energy is converted to potential energy in the form of heat and deformation of the contacts. As a result of elastic deformation, the moving contact rebounds from the stationary contact, the contact pair being re-closed by the contact force. This can occur one or more times until bouncing ceases and the contact system reaches static equilibrium.

If the electrical load is insignificant, contact transit time and bounce pattern are affected primarily by plunger position versus time, as well as by several variables in the design of the switch. A switch user seldom is concerned about, or even aware of, contact bounce unless the switch is controlling a device having very fast response. Some solid state circuits, for example, may interpret each bounce of the contacts as a separate signal. If this is objectionable, the remedy usually is a buffering circuit to remove the unwanted effects of contact bounce. Reducing ambient vibration, or increasing or decreasing plunger velocity, may reduce contact bounce time. Increasing plunger velocity usually reduces transit time. No attempt is made to control contact transit time or bounce characteristics during switch manufacture; in fact, they are only partially controllable. They are as much a function of the conditions of end use as they are of switch design.

Furthermore, contact transit and bounce time are inherently variable. In practice, two successive actuations of a switch seldom produce the same transit time, bounce pattern, or bounce duration, no matter how nearly constant the known variables are held. Given a switch installed in its end use equipment, measurement of an adequate number of contact closures enables one to make statistical estimates of contact behavior, assuming all variables remain constant. Some switch mechanisms have inherently low contact bounce time, and the switch manufacturer can provide specific information about them.

If the electrical load introduces significant thermal or arcing effects, contact transit and bounce time in themselves are seldom of concern. In addition to the effects mentioned above, separating contacts are affected by magnetic forces of repulsion associated with the arc. The pressure of metallic vapor at the interface also tends to drive the contacts apart. When separation of the contacts is due to bouncing, the contacts reclose with partially liquefied surfaces. From there on, things get complicated. If contact bounce or transit time is a matter of special concern, it is best to enlist the aid of a switch manufacturer.

E. Poles, throws and breaks

The terminology associated with the circuits of snap-acting switches can be understood with the help of **Figure 5** and the following definitions. The term ***pole*** denotes the number of completely separate circuits that can pass through the switch at one time. It is independent of the number of ***throws*** and number of ***breaks***. A double-pole switch can carry current through two circuits at the same time, since the circuits are completely insulated from each other. The circuits through the switch are mechanically connected (but electrically insulated) so they open simultaneously or close simultaneously.

Throw denotes the number of different circuits that each individual ***pole*** can control, independent of the number of ***poles*** and of ***breaks***. For example, a single-pole double-throw (single-break) switch connects the “common” terminal of the switch to the “normally closed” terminal when the plunger is free, but connects the “common” terminal to the “normally open” terminal when the plunger is depressed.

A ***break*** denotes the number of pairs of separated contacts the switch introduces into each circuit it opens. If actuating the switch breaks the circuit in two places, then the switch is a double-break switch.

Figure 5: Poles, throws and breaks

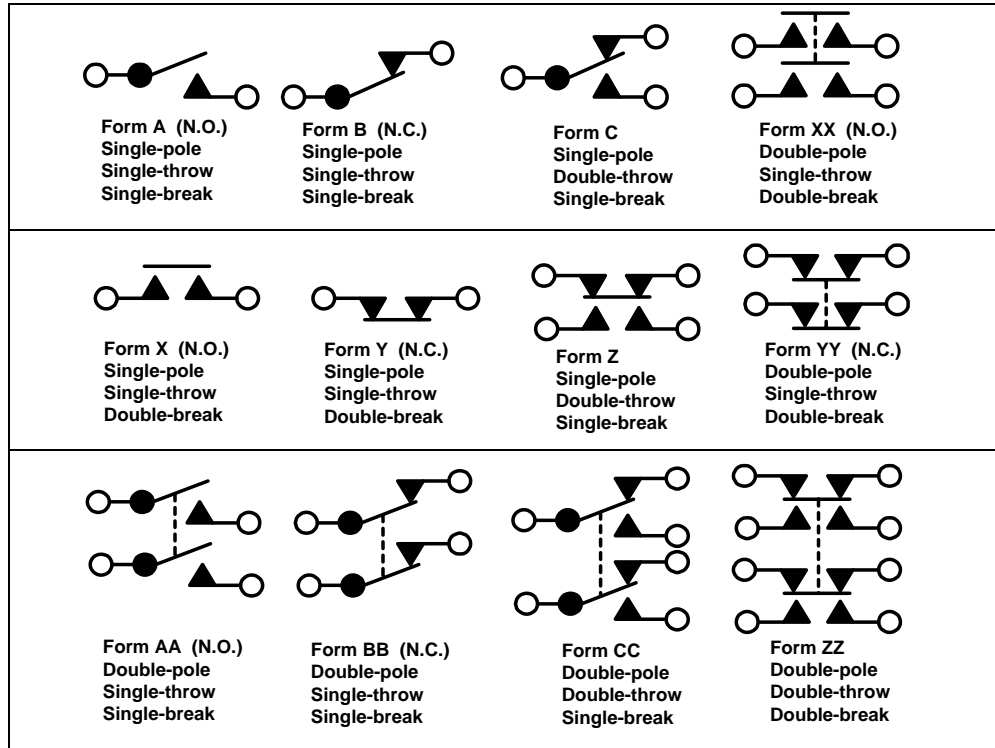

Poles - Number of independent circuits that can pass through the switch at one time.

Throws - Number of circuits that each individual pole of a switch can control.

Breaks - Number of pairs of separated contacts which are seen when a switch is operated.

II. THE ELECTRICAL CHARACTERISTICS OF A PRECISION SWITCH

Switches are used to close and open electrical circuits, carry current, and to hold the circuit either open or closed. An ideal switch would be one whose electrical resistance could be readily changed at will, from zero to infinity. The design of such a switch would first require the invention of a perfect conductor and a perfect insulator. It is interesting to note, however, that in most applications, an ideal switch of this kind would be no better than a precision snap-acting switch is today. An open snap-acting switch usually presents a circuit resistance of well over 100,000 megohms, and closing the switch reduces its resistance to a few milliohms. This represents a resistance change of 13 orders of magnitude in milliseconds. Two important electrical characteristics of a switch, then, are its resistance when open and its ability to conduct current when closed.

A. The resistance of an open switch

When a voltage is applied between two electrodes in or on an insulating material, a feeble current flows from one electrode to the other. The applied voltage divided by the current is the electrical resistance of the insulation, and is called the *insulation resistance*. When a voltage is applied between two non-connected terminals of a switch, a extremely low current flows through the insulation that separates and supports the terminals.

The applied voltage divided by the current is the insulation resistance of the switch, measured between those terminals. It usually is expressed in megohms, i.e., millions of ohms. Insulation resistance often is confused with another property, the *dielectric strength*. The dielectric strength of an insulating material is the highest electrical potential gradient that the material can withstand without breaking down. As a material property, it is calculated by dividing the breakdown voltage by the thickness of the insulating material between a pair of test electrodes. The dielectric strength of a switch between two non-connected terminals, is the maximum voltage that can be applied between the terminals without rupturing the insulation that separates them. It is expressed in volts.

Figure 6: Insulation resistance and dielectric strength

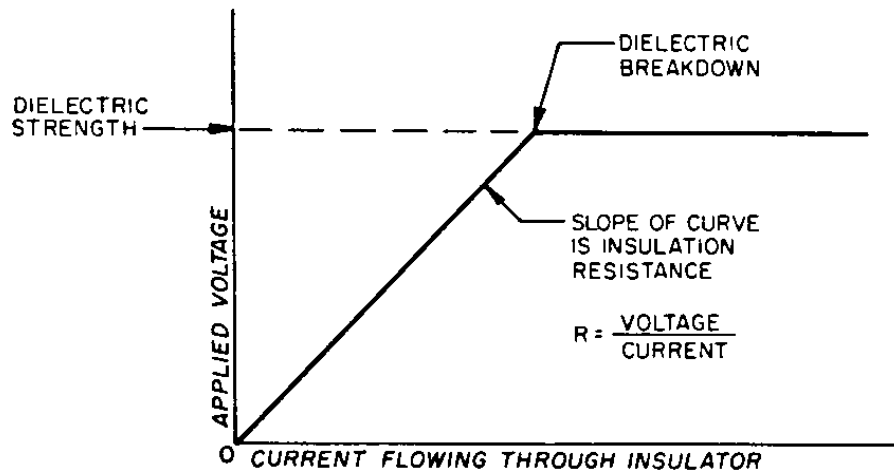

Figure 6 illustrates insulation resistance and dielectric strength of a switch as measured between a pair of non-connected terminals. As voltage is increased from zero, a proportionate current flows through the insulation. The higher the voltage the higher the current. The ratio of voltage to current is the resistance of the insulation and is called its insulation resistance. At several hundred volts, the resulting current may be of the order of microamperes. A newly manufactured switch at normal voltages usually has an insulation resistance well in excess of 100,000 megohms between non-connected terminals and between the terminals and switch mounting. The voltage puts an electrical stress on the material but does not damage it unless the potential exceeds the dielectric strength of the switch, usually well over 1,000 volts. When the voltage exceeds the dielectric strength, the insulating material is permanently damaged by the electrical stress and the insulation resistance decreases suddenly. Thus there is a sudden increase of current passing through the damaged insulator. The dielectric strength of a switch is somewhat lower if the voltage is applied suddenly rather than gradually. In other words, the rate at which the voltage is increased affects the dielectric strength.

During the life of a switch under normal conditions of application, both the insulation resistance and dielectric strength remain at satisfactorily high levels. Under some circumstances, which will be discussed later, the insulating material deteriorates and its insulation resistance drops to such a low level that the “open” switch passes appreciable current. This sometimes is the result of a drop in dielectric strength of the insulation to a level at which the circuit voltage ruptures the material and ruins the switch.

B. Capacitance of an open switch

When a switch is open, there usually is a voltage across the open contacts and the switch becomes a capacitor. Its capacitance is extremely low and is seldom of any practical concern, but occasionally it becomes a factor to consider in the design of a system. Because of the geometry and positioning of the internal parts, the capacitance of a switch is very difficult to calculate. Such a computation involves assumptions about the composite dielectric constant of the insulating material which introduces much uncertainty. Then too, the lead wires connected to the switch have capacitance, and their spacing affects its value. The switch mounting and its environment also influence capacitance. If capacitance is important, it must be measured, but the measurement procedure involves additional variables. The capacitance of a subminiature switch has been measured and found to be approximately 1 microfarad at 1000 Hz, when connected to an impedance bridge with two inches of #22 stranded lead wire. Changing anything, such as the length or position of a wire, could alter the measured value. The practical fact is that, if capacitance is to be measured, the measurement must be made with the switch installed in the end use equipment, with an environment similar to that of its application. Only then will a valid and useful capacitance figure be obtained.

C. Switches and radio frequency interference (RFI)

Electrical discharges between switch contacts can “broadcast” a signal that interferes with sensitive equipment nearby. This can also happen with a switch controlling milliamper circuits, although there is no electrical discharge and the broadcast signal is very weak. Such a weak signal can affect only extremely sensitive equipment near the switch. A telemetry system, for example, may be disturbed by spurious signals emanating from a nearby switch. Problems of this kind are rare, and when they occur they can better be treated individually than by wholesale preventive measures. In fact, misguided prevention can cause delays, increase costs and accomplish nothing useful. If, as a routine, procurement specifications carry the requirement that “this product shall conform to the requirements of specification MIL-I_____,” the costs of negotiation, designing, testing and correspondence can be huge, and the end use may not benefit anyone.

The cause and cure of RFI problems lies more in the application of the switch than in the switch design. The design of the switch governs the shielding effectiveness afforded by the switch. It also affects the amplitude and duration of RFI to some extent, but the circuit parameters are primary determinants. In contrast to the switch design, the application governs the following:

- Susceptibility of the system to conducted and radiated interference.
- The number, location, and physical arrangement of switches.
- Shielding and wiring.
- Circuit parameters.
- The frequency of switch operation.
- The number and type of noise generators other than switches.

Thus, the application, far more than the switch, determines the incidence and seriousness of RFI problems.

Given what appears to be an RFI problem, the first step is to ascertain that the problem actually is due to RFI. If careful tests of the equipment show that the problem definitely is caused by RFI, the next step is to locate the source of the RFI. If the problem is traced to the switch, and if the source of the interference is an arc at the switch contacts, an arc suppression circuit will reduce the problem and may suffice as a remedy. See Chapter V, Section F, Arc Control, for details. If this is not feasible, or if an arc is not present at the switch contacts, determine whether the unwanted signal is being transmitted by conduction, radiation or both.

For conducted interference from a switch, the best remedy is a filter attached to the switch wiring terminals. The filter should be designed to be compatible with the particular system. “Universal” filters tend to be large and expensive.

Radiated interference from a switch is remedied by shielding. If the switch could be completely covered by a conductive shell, all radiated RFI would be prevented. This is not always practical because terminals must be electrically isolated, and mechanical force and motion must be transmitted to the switch mechanism. The actuation problem can be remedied by operating the switch through a metal diaphragm or bellows. Hermetically sealed switches are available, which are completely housed in metal except for glass terminal insulators. These switches are quite effective in reducing interference levels. Radiation from the lead wires can be controlled by the use of shielded wire.

D. The resistance of a closed switch

Chapter III is devoted to the subject of switch resistance.

III. SWITCH RESISTANCE

The world's attention was centered on a steel tower in the desert as the moment approached for the test firing of a new atomic weapon. Years of painstaking and costly development had culminated in the sophisticated device that was now ready atop the tower. The area had been cleared; observers were at their posts in blockhouses; monitoring instruments were connected. The firing time was announced to be in minutes, then in seconds. As the countdown reached zero everyone held their breath. . . The silence lengthened into seconds and then into minutes. The tower remained. There had been no blinding flash. Not even a flicker. No mushroom shaped cloud darkened the sky. "E", it would seem, had not equaled " mc^2 ". Could the scientists and engineers, who had achieved such brilliant success with previous atomic devices, somehow have miscalculated this time? The question was of particular interest to the task force whose duty now was to disarm the device so the trouble could be traced. Eventually the fault was found in a control circuit, and was traced to a miniature snap-acting switch. During installation of the switch, solder flux had entered the case and coated the contacts. It wasn't much, but it was enough to abort the test. For practical purposes, the "closed" switch had infinite resistance. This extreme example illustrates the fact that a little practical knowledge about switch resistance can save time, money, and reputation.

In the instance cited, careless installation disabled the switch. On the other hand, countless examples could be cited in which the user has heard of switch resistance, fears it, and has tried to minimize it with stringent procurement specifications. Tightening specifications can be costly, time consuming, and sometimes ludicrous. Consider the not so unusual demand that switch resistance does not exceed .025 ohm, even though the component that the switch is to control has a resistance of thousands of ohms. Such a sensitive circuit would demand a fantastically stable power supply!

Problems with switch resistance usually are the result of carelessness or misdirected caution. These, in turn, stem from inadequate understanding of switch resistance. The remedy lies in being informed about the nature and behavior of switch resistance so that sound technical judgment can prevail. One can then recognize those relatively infrequent instances in which a switch resistance specification is needed, and can then write useful specifications. Fortunately, practical knowledge of switch resistance is not difficult to acquire. This chapter presents the facts needed for competent handling of switch resistance.

Figure 7: Sources of switch resistance

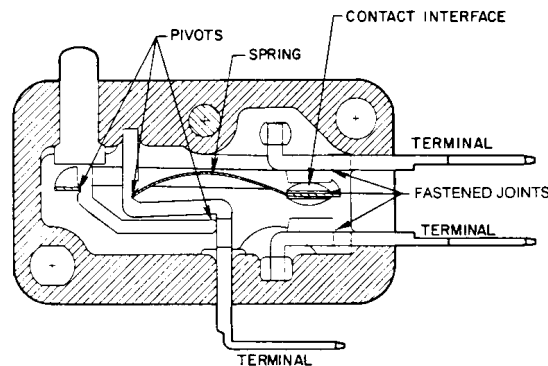

A. Sources of switch resistance

Switch resistance is the total resistance of the conducting path between the wiring terminals of the switch. This is the resistance “seen” by the circuit and is the value usually specified and measured, although often it is erroneously called contact resistance. Switch resistance is the sum of the bulk resistance of all parts that make up the conducting path through the switch, plus the resistance of the joints or interfaces between these parts. The joints may be staked, bolted or welded. They may be bearings, such as knife-edge pivots through which the current passes. The joint may be a contact interface, i.e., a connection that is joined and separated by the switch mechanism. The resistance across the pair of closed contacts is the *contact resistance*.

In a properly designed and manufactured snap-acting switch, the joint or connection between the contacts provides the only significantly variable resistance in the switch. Switch resistance can never be less than it would be if the contacts were soldered or welded together. This resistance typically is of the order of .005 to .050 ohm, and depends upon the materials and design of the switch. The design, in turn, is governed by the use for which the switch is intended. A switch designed for use at high temperature, for example, may require special spring material having higher than usual electrical resistivity.

B. Typical pattern and magnitude of switch resistance

Because the resistance of the contact interface varies, so does the resistance of the switch. Switch resistance varies as the switch plunger is moved through its travel during one cycle of operation, and it varies from one cycle of operation to another. When measured at 6 volts DC at 0.1 ampere, switch resistance may vary when the plunger is moved from its free position to operating point as shown in **Figure 8**. The particular pattern and magnitude of resistance depends upon several variables which will be discussed later.

Figure 8: Typical pattern of switch resistance versus plunger position at 6 volts DC at 0.1 ampere

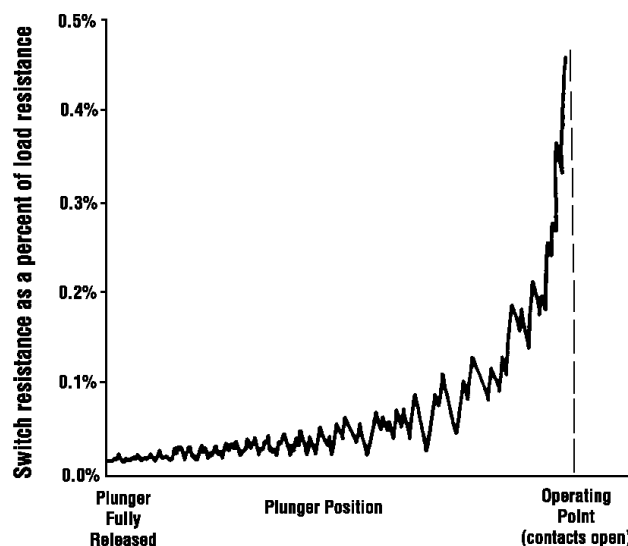

To study the behavior of switch resistance over the life of a switch, MICRO SWITCH developed automatic recording equipment to plot a point on a resistance graph during each closure of the switch contacts. Switches from various manufacturers were tested using this equipment. **Figure 9** shows typical resistance of various standard switches at 6 volts DC at 0.1 ampere during 10,000 operations. The test circuit has a load resistance of 60 ohms. During these tests, switch resistance ranged, for the most part, from .005 to .020 ohm, with an occasional overshoot to as high as .038 ohm. In no instance did switch resistance exceed .063% of the 60 ohm load resistance. It is interesting and important to note that when the load resistance is lower, the switch resistance tends to be lower. When load resistance is higher, switch resistance tends to be higher, too. In general, if source voltage is 0.5 volt or greater, switch resistance tends to be a small part of the load resistance. During the life of a switch that is properly chosen for its end use and is correctly installed, switch resistance almost never exceeds 1% of the load resistance. **Figure 10** provides a graph for calculation of maximum switch resistance, based on this principle.

Figure 9: Resistance of various switches during 10,000 operations

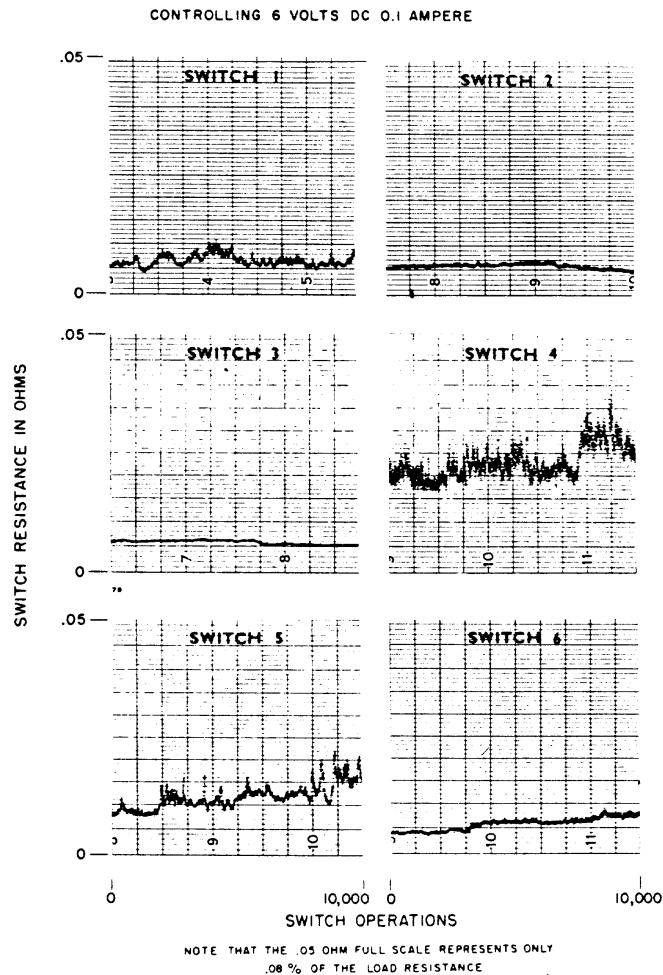
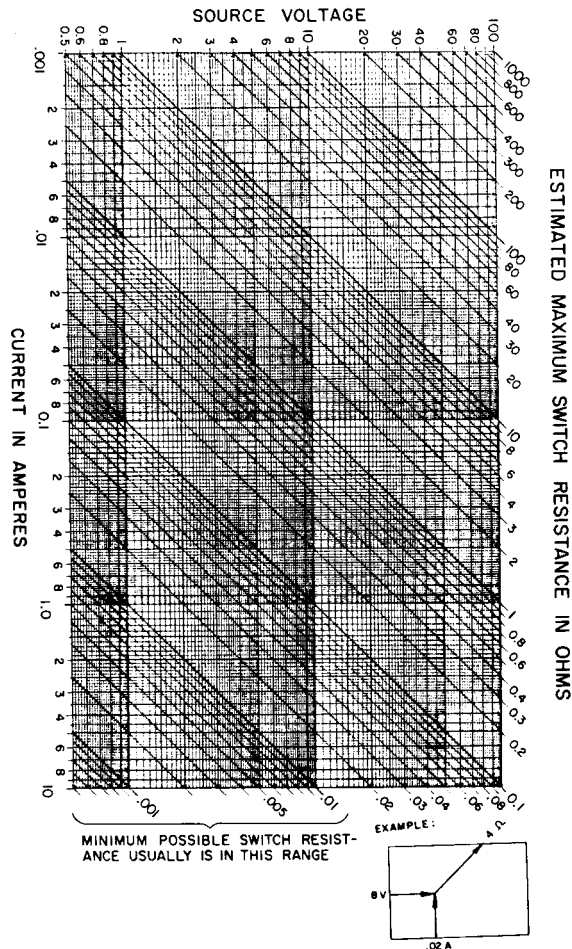

Figure 10: Maximum resistance of snap-acting switches



C. Why switch resistance behaves as it does

The apparent dependence of switch resistance upon load resistance is not mysterious, if we consider events at the interface between the switch contacts.

For practical purposes, it can be assumed that heat flows through a pair of contacts along the same path as that of the electric current. As a result, the voltage across a pair of current carrying switch contacts is an approximate measure of the temperature of the metal at the interface between them (see Holm, R. *ELECTRIC CONTACTS*, 4th edition, p.60ff, for details). For this reason, one can speak of “softening and melting voltages” of contact material, just as one speaks of the softening and melting temperatures. Table I gives approximate values for silver and gold contacts.

TABLE I		
Material	Approximate Softening Voltage	Approximate Melting Voltage
Silver	.09 Volt	.37 Volt
Gold	.08 Volt	.43 Volt

Since the voltage measured across a pair of closed contacts is an index of temperature at the contact interface, it follows that the voltage impressed across a pair of closed contacts will determine the temperature. If this voltage exceeds the softening voltage of the contact material, the metal at the interface will soften. If the voltage reaches the melting voltage of the material, the metal at the interface will melt. The softening and melting are due to I^2R heating. They take place on the microscopic scale, but they control contact resistance. If the metal at the contact interface softens or melts, the cross sectional area of the conducting path between the contacts will depend upon the current. This area determines the resistance of the conducting path, and therefore, the contact resistance. If melting occurs, a metallic bridge will be established and its cross sectional area will increase until it can carry the current in the solid state. The higher the current, the greater the cross sectional area of the bridge and the lower its resistance. If the softening voltage is not reached, the size of the conducting path is not affected by current, and contact resistance will be independent of current.

In the application of snap-acting switches, if the source voltage is at least 0.5 volts, contact material almost always softens, or melts slightly, at the interface, and switch resistance becomes a function of current. This leads to the following practical consequences:

1. In low current circuits, switch resistance tends to be relatively high. However, low current circuits usually have high-resistance load components. The resistance of the switch usually is such a small part of the total resistance of the circuit that switch resistance is no problem.
2. High current circuits usually have low resistance load components. In high current circuits however, switch resistance tends to be low. Again, the resistance of the switch is such a small part of the total resistance of the circuit that switch resistance is no problem.

In general, at source voltages of 0.5 volts or greater, the resistance of a switch during its life almost never exceeds 1% of the load resistance. If source voltage is less than 0.5 volts, switch resistance may or may not be a function of current, depending upon the amount of the source voltage that appears across the switch contacts. If source voltage is less than .08 volts, softening cannot occur and switch resistance is independent of current. Voltage also serves to help establish electrical continuity during contact closure, by breaking through surface contaminants. The higher the voltage, the greater the assurance that the switch will close the circuit. In practice, if switch resistance is a critical factor, it is best to consult the switch manufacturer for specific advice.

D. The role of contamination in switch resistance

In those infrequent instances in which the resistance of a switch is high enough to cause trouble in a circuit, the problem almost invariably can be traced to contamination of the contacts. Contact contaminants often are subtle, elusive, and nearly invisible even under a microscope. The high resistance condition can be intermittent as particles of dust or other foreign material move about on the contact surfaces. A particle .001" in diameter, falling from a height of six feet, would require more than 1 1/2 minutes to reach the floor. Yet, one particle much smaller than this can hold the contacts of a switch apart and cause an open circuit.

Contact contaminants generally are classified according to their gross characteristics as particles or films. Contact films may be subdivided into those which are completely alien to the contact, such as an oil film, and those that are a chemical compound of contact material and contaminant. Usually the contaminant is readily identified and the problem is remedied at its source. There remain those instances in which the contaminant appears to have been generated spontaneously at the contacts, and there is too little of the material for easy identification or analysis. In such cases, the problem must be treated on an individual basis by the switch manufacturer, utilizing the best available knowledge and analytical techniques. The following is a description of the most common contaminants:

Solder Flux

Minute amounts of flux can enter a switch as liquid or vapor during or after soldering of leads to the terminals. This flux can be trapped between the contacts. To avoid this, follow these practices:

- choose an inactive type flux,
- use flux sparingly,
- use flux core solder,
- prevent liquid flux or flux vapor to enter the switch,
- use a soldering temperature of approximately 550°F (287°C).
- avoid solvent use on or near switches - they may carry flux residue and other contaminants into the switch (it is not necessary to remove flux residue from switch terminals).

Crushed Solids

Particles of foreign material can enter an unsealed switch and be crushed beyond recognition between the contacts. Switches are designed to have high contact force to assure good electrical continuity. This can pulverize brittle material and trap enough of the resulting powder between the contacts to cause problems.

Carbon

Organic materials, especially organic vapors, can decompose on the contact surface leaving an ash residue of carbon. This can occur whether or not there is an arc at the contacts. If there is no arc, energy comes from friction and I^2R heating of the material at the interface between the closed contacts. The vapor adsorbs on the contact surfaces and is decomposed by the energy dissipated at the point where the contacts touch. If an arc is present, it can decompose organic material directly without adsorption. Increasing the current will increase the yield of carbon, but if an arc is present, it will also increase the tendency of the discharge to evaporate the carbon and to blast the contact surfaces clean. The most effective remedy, usually, is elimination of organic vapor contaminants.

Polymer

Under some conditions, simple organic contaminants can combine into long chain compounds (polymers) in a reaction catalyzed by the contact material. For this to occur, the organic material must be in the form of vapor. The vapor adsorbs on the contact surface and the reaction proceeds from there. Silver does not form polymers because it does not adsorb vapor. Gold can form polymers. Polymers forming between contacts are of several types, having various characteristics. They form only during the sliding or wiping of contacts, but this may be on the microscopic scale as metals deform under the contact force.

Chemical Compounds of Contact Material and Foreign Material

When an unsealed switch is exposed to chemical vapors, the contact material may react with the vapor to produce sulfides, oxides, chlorides, nitrates, or other compounds. The most common occurrence of this kind is the tarnishing of silver contacts in the presence of H₂S (hydrogen sulfide) and water vapor. The H₂S can come from many sources, such as decaying organic matter, cardboard, and vulcanized rubber insulation. This tarnishing seldom affects switch performance, but occasionally small amounts of silver sulfide collect between the contacts and increase the resistance of the switch. If, for some reason, the switch cannot be sealed and the sulfide cannot be eliminated from the environment of the switch, special contact materials may be used. Gold does not tarnish, but it is expensive. Various alloys of gold and silver, often with a ternary addition, preserve much of the tarnish-resistant quality of gold without the expense of gold. Another approach is electroplating. Its effectiveness depends upon the base metal, the nature and thickness of the plate and subplate, a number of variables in the cleaning and plating processes, and several factors in the design of the switch mechanism. Simply specifying a gold plate is useless. In fact, some kinds of gold plate can aggravate tarnishing of the base metal.

Condensed Metal Vapor

When an arc is present, evaporated metal may condense in the form of powder on the contacts and adjacent surfaces. Its color may be yellow, brown, black or metallic. Condensed metal vapor seldom affects performance of the switch significantly.

Effect of Silicone on Electrical Contacts

Silicone is a polysiloxane polymer which consists of a chain of silicon (Si) and oxygen (O) atoms along with other groups attached to the silicon-oxygen chain. Silicones will degrade and break down under electrical load into silicon (Si), oxygen (O) and other elements which may be present in the polysiloxane chain. The effect of silicones on electrical contacts depends upon the amount of silicone present on the contacts, the electrical load switched by the contacts and the number of electrical operations made by the contacts. Silicon dioxide (SiO₂) which is sand or glass is formed as a result of thermal decomposition of silicone under electrical load. Glass is an insulator and will cause erratic contact if present at the area of contact mating. The appearance of the degraded silicone contamination is usually black and it is generally only a few micro inches thick. A variety of products contain silicones, e.g.; lubricants, water repellents, release agents, silicone sprays, greases, waxes, resins, rubbers, etc.. Silicones or products containing silicone must be prevented from entering the contact area of a switch. Use of an environmentally sealed switch or other preventative measure may be necessary.

Migration of Silicones

Silicone vapors have a tendency to migrate and are drawn by electrostatic charge between electrical contacts. Therefore, if silicones are used in the near vicinity of a switch, the outgassed silicone vapors will end up between the contacts in environmentally unsealed switches. The silicones can then gradually degrade under electrical load to form an electrically insulating silica (SiO_2) film on the contacts resulting in an electrical intermittence problem, high resistance or an electrical open circuit. The extent of electrical resistance problem will depend upon the amount of silica deposited on the contacts as a result of the decomposition of the silicone present between the contacts.

Wear Particles

The generation of contact wear particles is affected by selection of contact material, contact fabrication (cold working and annealing), contact assembly (staking or welding), lubrication (intentional or otherwise), contact force, and contact sliding. The effect of wear particles on switch resistance is governed by these factors and by distribution of particles in the wear track, as well as by the number of cycles of switch operation.

The remedy of contact contamination problems depend upon accurate identification of the type and source of the material between the contacts. To make this possible, it is best to return the switch in question, UNOPENED, to the switch manufacturer, in a plastic bag or other lint free container.

While the user should not specify contact material, he is entitled to know how the switch manufacturer decides what material to recommend. The use of gold contacts often is associated with low voltage and current. But just when should gold be used? The answer is not just a set of circuit parameters, and the decision often is difficult to make, but here are some of the considerations.

E. Choices of contact material

The most commonly used contact material is silver. Silver combines the chemical, electrical, thermal and mechanical properties that provide the best overall contact performance in a wide range of applications. If silver contacts are clean, there is no lower limit to the voltage and current that they will reliably control. This applies, for example, to a switch that is sealed sufficiently to keep out contaminants. Silver has the drawback that it tarnishes in the presence of H_2S and moisture. It is this characteristic that encourages the use of gold contacts in some applications.

Before discussing contact material further, the problem of switch resistance should be put into perspective. Practical problems with switch resistance are almost always due to careless soldering procedures, which contaminate the contacts with flux, or to particles of other contaminants settling between the contacts. Changing contact material has no effect upon such problems.

As mentioned previously, if silver contacts are exposed to sulfides and moisture for a long enough time and in sufficient concentrations, the contacts will tarnish. This seldom affects performance of the switch. The combination of mechanical force, contact movement, and the circuit voltage, almost always ruptures the tarnish film and establishes good electrical continuity. Occasionally, however, small amounts of silver sulfide may collect at the contact interface and increase the resistance of the closed switch enough to constitute an open circuit. Generally such a malfunction clears up on the next switch closure, but it may not. The likelihood that silver contacts will experience this kind of problem depends upon the voltage, current, inductive characteristics of the circuit, the temperature, humidity and purity of the environment, the degree of seal of the switch enclosure, the mechanical forces and movement of the switch contacts, the exposure time and number of switch operations, and the amount of switch resistance that constitutes an effectively open circuit.

Gold is nearly inert chemically, and does not form sulfides or oxides in normal switching environments. Gold has some important limitations as a contact material. It is expensive, soft and ductile, and its usefulness is very limited where an electric arc is present. It does, however, prevent sulfide tarnishing if properly applied. To reduce cost and make contacts more nearly universal, silver contacts sometimes are plated with gold. Thus, the theory goes, if the voltage and current are low enough to make gold contacts desirable, they are low enough that they will not disturb the gold plate. If voltage and current are too high for gold contacts, they will burn the plate off and expose the silver which is suitable for higher loads. However, there are some practical limitations. If gold is plated directly on silver contacts, sulfur atoms in the presence of moisture can penetrate the pores in the gold plate, and react with the silver base metal, forming silver sulfide. The sulfide then migrates rapidly over the surface of the gold plate as a spongy deposit that can cause more trouble than would a sulfide tarnish on an unprotected silver contact. The heavier the gold plate, the more slowly this will happen, but the more expensive the switch will be. The usual procedure is to use a nickel barrier plate between the silver base metal and the gold plate. This stops the sulfide problem, but adds to the cost, and sometimes is incompatible with production processes.

Aside from cost, the answer would seem to be solid gold contacts, but gold is very ductile and may experience plastic flow under the influence of contact force on closure. This can be remedied by alloying other elements with the gold to harden it. Sometimes it is possible to alloy a high enough percentage of other elements with the gold that the cost of the contact can be significantly reduced. But this introduces other considerations; for example, polymer formation. Gold and gold alloy contacts can generate polymers at the contact interface when organic contaminants are present in the atmosphere. Silver does not form polymers. The type of polymer usually formed on pure gold contacts does not increase switch resistance, but the same is not always true for gold alloys. If the atmosphere around gold or gold alloy contacts is clean, no polymer will be formed. Under the same conditions, silver contacts will not form polymer or sulfide, and are considerably less expensive. In short, the choice of contact material involves a number of considerations and often a tradeoff decision.

Other contact materials sometimes are used for applications of this kind. The most common materials are platinum, palladium, and their alloys. Although these materials are sometimes used as pure metals, they tend to have poor wear properties and are very soft. Hence the alloys, which preserve some of the desirable properties of the elemental materials and improve hardness and wear resistance. The principal alloying elements are other metals of the platinum group, such as iridium, ruthenium, osmium and rhodium. Others are silver, copper and nickel. Most of the platinum and palladium alloys can form polymers that increase switch resistance.

In summary, although no universal rules can be laid down, the following practices usually are followed. If the switch is sealed, sulfides cannot enter and silver contacts are used. If the switch is unsealed, the electrical load is considered. If there is an electric arc, silver contacts are used. If there is no arc, the environment is a controlling factor. If particle contamination is likely to reach the contacts, gold is no help. Use a sealed switch or bifurcated contacts. If a completely alien film contaminant such as paint spray or oil mist can reach the contacts, gold does not help. Use a sealed switch. If the environment of an unsealed switch contains significant amounts of H₂S (from such sources as decaying organic matter, cardboard, or vulcanized rubber) and moisture, gold contacts can be a real help.

F. How switch design affects resistance

In designing switches, the logical way to prevent contamination of contacts by the environment is to enclose the mechanism in such a way that foreign material cannot enter the switch. The plastic case of the common snap-acting switch does this adequately for most applications. Switches with sealed enclosures are available where they are needed for particularly dirty environments. Aside from a protective enclosure, four features of switch design are important in minimizing resistance problems arising from contamination. These are:

1. contact material,
2. contact geometry,
3. contact force, and
4. contact movement after closure.

A discussion of switch design is beyond the scope of this book, but it is well to remember that these four factors must be considered together, and it is their combination that controls contact resistance.

For the most part, the contacts of snap-acting switches are of the sphere against plane type. In some cases, the surfaces are serrated or knurled. Others utilize chisel or wedge shaped contacts against a flat or spherical surface. Crossed cylinder contacts have been used for over 40 years in switching devices where particles of dust or other contaminants may be present. Some snap-acting switches still employ crossed cylinder or crossed prism contacts, while others accomplish the same purpose with point to plane or other contact geometries. The most effective system developed to date is the bifurcated contact which provides parallel redundancy and reduces the average contact resistance while providing an extra path for current, in case one path is blocked. Redundancy can also be achieved by connecting two or more switches in parallel and actuating them at the same time.

The user gains nothing by specifying contact material, contact force, or other features of the internal design of the switch. In fact, by doing so, the cost is likely to increase and switch performance may degrade. Instead, the wise user specifies what the switch must do, and the switch manufacturer selects or designs the switch to perform as required at as low a cost as possible.

G. How to measure switch resistance

How should switch resistance be measured? If the resistance of a given switch is measured, in turn, with an ohmmeter, a bridge circuit, and the voltmeter-ammeter method (measuring voltage across the switch at a specified current), it will be found that no two methods yield the same result. This is understandable in view of the foregoing discussion. A switch does not have a fixed resistance. The measured resistance of a switch depends to a large extent upon the way in which it is measured.

If this is the case, how can meaningful measurements be made? They can be made by keeping the variables as realistic as possible in view of the intended use of the switch.

Voltage

The source voltage of the measuring circuit should be the same as that of the circuit in which the switch is to be used. The higher the source voltage, the more likely is the switch to close the circuit with good electrical continuity. A measuring circuit having higher or lower source voltage than that of the end use, can give unduly optimistic or pessimistic results.

Current

The current of the measuring circuit should be the same as that of the circuit in which the switch is to be used.

The Measuring Circuit

The above discussion has shown the importance of specifying and controlling the voltage and current at which the switch resistance is measured. This is most easily accomplished by connecting the switch in a simple series circuit, consisting of a power supply at the specified voltage, a variable resistor, an ammeter and the test switch. The resistor is adjusted until the specified current is attained. With this current passing through the switch, the voltage drop across the switch terminals is measured with a voltmeter, using a separate set of test prods for the voltmeter connection as shown in **Figure 11**. The measured voltage is divided by the current to calculate the switch resistance. It is essential that separate current and voltage connections be used, as described, to avoid including the terminal connection resistance as though it were part of the switch resistance.

Figure 11: Connections for measurement of switch resistance

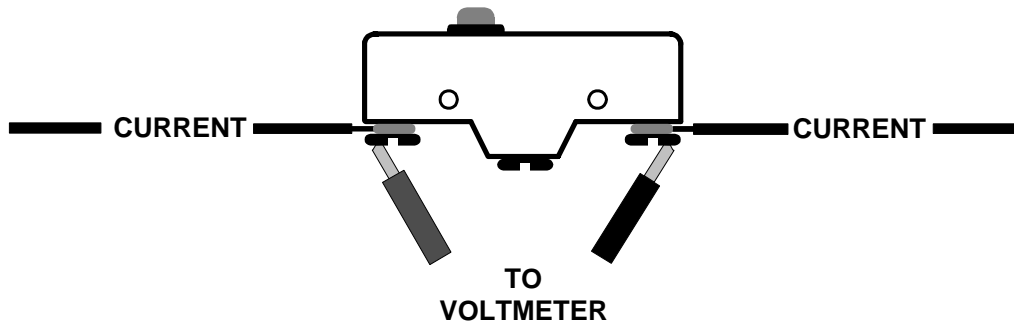

Switch Plunger Position

In most precision snap-acting switches, the resistance varies with plunger position (see **Figure 8**). When measuring switch resistance, the switch plunger should be held at the point of its travel where it will be held in actual use at the time when switch resistance is important.

Sequence of Operations in Measuring Switch Resistance

If the switch closes the electrical circuit, the voltage is present at the contacts at the time they close. The voltage assists the mechanical forces in breaking through any contaminant which may be present between the contacts. If, on the other hand, the switch is closed before the voltage is applied, the mechanical and electrical forces are applied to the contaminant in sequence rather than simultaneously. There is somewhat less likelihood, then, that continuity will be established. When measuring switch resistance, the sequence of contact opening and closure, and application of voltage to the switch should be the same as it will be in end use. Avoid the practice of measuring switch resistance at one combination of current and voltage, following an endurance test at a different current or voltage. Such a measurement has no practical value.

To summarize measurement principles, switch resistance is properly measured by duplicating as nearly as possible the voltage, current, switch plunger position, and sequence of operation that will prevail when the switch is in its end use. The voltmeter-ammeter method is used to permit control of the major electrical variables. Separate current and voltage connections are made to the switch terminals, and switch resistance is then calculated from Ohm's law.

H. When to give switch resistance special attention

1. When the switch controls a circuit at less than 0.5 volt.
2. When several switches must be connected in series.
3. When a switch is likely to be exposed to contaminating particles or fumes.
4. When an occasional switch closure with switch resistance exceeding 1% of the load resistance will have dire consequences.

I. How to be constructively cautious about switch resistance

1. Design the circuit to be as insensitive to normal variations of switch resistance as possible.
2. Design the circuit so that the switch will see voltages well above the softening voltage of the contact material.
3. Design low voltage circuits with a minimum number of switches in series.
4. Store switches in a clean, reasonably dry environment that does not exceed the rated temperature of the switch.
5. Install the switch carefully. Do not drill, sand, or otherwise modify the switch without checking first with the switch manufacturer. Do not overtighten mounting screws. If mounting the switch with an adhesive, use extreme care to avoid contaminating the interior of the switch. When soldering leads to terminals, use flux core solder and a soldering temperature of about 550°F (287°C). Do not use solvents on switches. Do not use commercial contact cleaners on snap-acting switches. Do not paint over switches after installation. Protect unsealed switches from contamination by particles and fumes.

6. Actuate the switch as nearly as possible to the extremes of its plunger travel without applying excessive force that might damage the switch (Force figures available from manufacturer).
7. Decide, using solid technical grounds, whether a switch resistance specification is needed and whether its additional cost is justified. If so, specify the voltage, current, plunger position, sequence of actuation and measurement, and maximum allowable switch resistance based on end use.
8. If additional assurance of low and stable resistance is desired, connect two or more switches in parallel and actuate them at the same time.
9. Test the switch under conditions simulating end use to verify that it performs as required.
10. Get advice from a switch manufacturer regarding choice of switch and suggestions about specific application.

IV. STABILITY OF MECHANICAL OPERATING CHARACTERISTICS

A. Normal variation of operating and release point

One of the advantages of precision switches is the extreme stability of their operating characteristics. Many control devices such as thermostats and pressure controls utilize this feature to simplify design. Currency counting machines in large banks and department stores employ precision switches to detect bills passing between a pair of feed rollers, and to stop the machine if two bills are fed through a pair of rollers at the same time. The operating characteristics of most interest, in this regard, are the operating and release point, refer to **Figure 2**. But just how stable they are depends upon the type and quality of the switch and the way in which it is applied.

A precision snap-acting switch, when actuated just through its differential travel (while controlling a negligible electrical load at room conditions), is likely to undergo a “settling in” period during the first several hundred operations, until the system (including the switch, its actuating mechanism, and associated operating cam or linkage) stabilizes. During this period, the operating and release point are likely to shift together, a distance of perhaps .0005”, maintaining a fairly constant differential travel. If the system is left undisturbed mechanically, the operating and release point will stabilize, perhaps varying within a band no wider than about .0002 inch per 100,000 operations. Needless to say, precision of this order seldom is required. Any significant disturbance, such as a mechanical shock, will result in another stabilization period, similar to the first one. The “settling in” is a stabilizing of the entire system, including the switch, so a preliminary run in of the switch alone, before installing it in the system, is useless. In fact, it degrades the switch by accumulating bearing wear and spring fatigue.

B. How stability is affected by factors in the application

Many variables in end use can affect the stability of operating and release point of the switch during its life. The most important ones are described below.

Selection of the Switch

Some switches are designed especially for stability of operating and release points, while others are designed to optimize other features. If especially stable operating and release points are needed, the switch should be chosen with this in mind, using the help of the switch manufacturer.

Mounting the Switch

If the surface against which the switch is mounted is warped or rough, or if the mounting screws are over tightened, the stability of operating and release points may be reduced. Precision switches are ruggedly constructed and will take considerable abuse. At the same time, the switch is a precise component and its precision can suffer if undue mounting stresses are applied.

Soldering Lead Wires to the Terminals

Overheating the terminals of a switch with a soldering iron can partially anneal the internal spring and distort the plastic insulators, either or both of which reduce the precision of the switch. Miniature and sub-miniature switches are especially sensitive to this type of overheating.

Actuation

Many basic switches are provided with leaf springs, levers, or other linkages between the switch plunger and the actuating device, which are used to provide additional overtravel, reduce the operating force, and for other reasons. The differential travel measured at the free end of the leaf or lever often is considerably greater than that measured at the switch plunger. A ratio as high as 20 to 1 is not unusual. This feature provides the operating characteristics needed in many applications. However, it may also magnify any instability of the operating and release point.

The greatest precision is achieved by actuating the switch at the plunger, parallel to the plunger axis. An actuating device that strikes the switch plunger at an angle will not achieve maximum operating and release point stability. Such actuation applies side thrust to the plunger, promoting wear of the plunger bearing surfaces and reducing the precision of the switch. Furthermore, when the actuating device strikes the plunger at an angle to the plunger axis, any shift of operating or release point will be magnified. If the switch plunger is driven directly by a cam, rubbing can cause excessive wear and changes of operating characteristics, unless the plunger is designed to serve as a cam follower. Switches can tolerate considerable force on the plunger without damage, but excessive force can shift the operating characteristics and cause permanent damage to the mechanism. Switch manufacturers can supply information on the maximum forces recommended.

Electrical Load

In the precision switch industry, it is standard to establish current ratings with life tests in which the switch plunger is fully depressed and fully released during each cycle of operation. This represents the actuation the switch will receive in many end use applications, but it gives no indication of the effect of current on operating and release points. Precision switches provide their most precise control at low current, and are used at rated current in applications where maximum precision is not required. To learn more about the behavior of operating and release points during switch life, automatic recording equipment has been developed by MICRO SWITCH to plot these characteristics as points on graph paper. The completed graph presents a concise picture of operating and release points during switch life, allowing the effects of design variables and electrical load to be studied. Plunger travel is magnified 1000 times by the recording equipment, so 1 inch on the vertical scale of the graph represents .001 inch of plunger travel. The time scale is so arranged that many thousands of operations are plotted in a short distance. If the points are closely clustered they may appear as a solid line or a dark mass on the paper, but any "maverick" points will appear as individual dots.

Switches from various manufacturers have been tested on this equipment. **Figure 12** shows typical results. With a switch controlling a negligible electrical load, such as 100 milliamperes, the first few hundred operations usually cause a slight shift of operating and release points in the same direction, as the system (consisting of switch and measuring equipment) settles and stabilizes. The differential travel remains virtually unchanged, and stabilizes as shown in **Figure 12, (a)**. When a 5 ampere 120 volt AC resistive circuit is connected to the normally open circuit of the switch, the trace changes as shown in **Figure 12, (b)**. The operating points are unaffected, but phenomena at the switch contacts (contact welding, erosion, etc.) cause some dispersion of release points. Most of the release points still lie along the line they occupied under essentially no-load conditions, but some of them shift in the direction that expands the differential travel.

Figure 12: Electrical load effect on the operate and release points

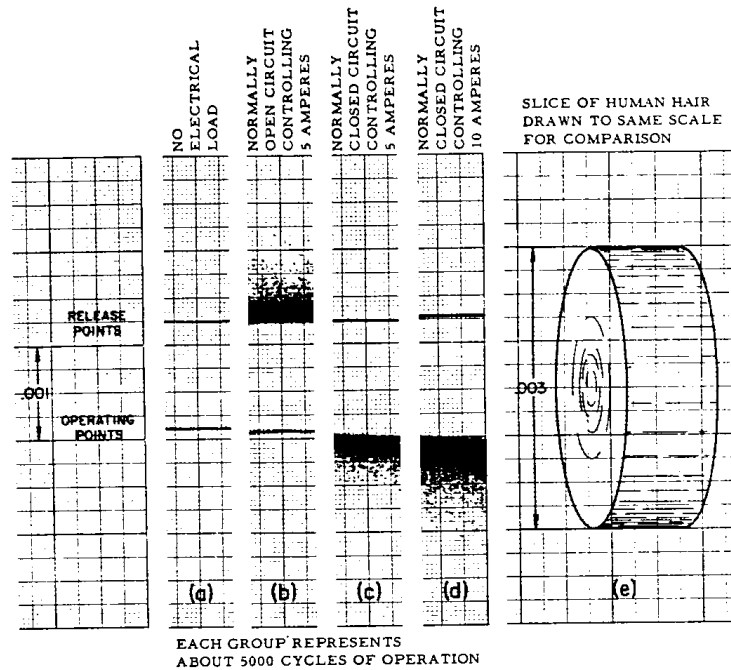

If, instead of connecting the 5 ampere load to the normally open circuit of the switch, we connect it to the normally closed circuit, the pattern of **Figure 12, (c)** emerges. Here the release points are dispersed as shown. Most operating points lie along the no-load line but some are shifted in the direction of expanding differential travel.

Most (but not all) switches tend to be less affected by an electrical load on the normally closed circuit than by the same load on the normally open circuit. The difference is more apparent at higher current. If the 5 ampere load through the normally closed circuit of the switch is increased to 10 amperes, the switch responds as shown in **Figure 12, (d)**. A glance at the vertical scale and the diameter of the human hair on the same scale, **Figure 12, (e)**, shows that the scatter of points is quite small.

Summary of Facts About Operating and Release Point Versus Electrical Load

Loading the normally closed circuit of the switch affects some of the operating points, but none of the release points. Conversely, loading the normally open circuit affects some of the release points, but none of the operating points. At a given current, differential travel will usually be more stable if the electrical load is controlled by the normally closed circuit of the switch rather than the normally open. Electrical loading tends to increase the differential travel during some, but not all cycles of switch operation. The lower the current, the narrower the dispersion of differential travel and the fewer cycles of operation that will experience widening of the differential travel. The amount of change of differential travel, of course, depends upon the design of the switch and the conditions of end use.

Acceleration, Vibration and Shock

As the switch plunger approaches the operating or release point, the contact force decreases, and the switch becomes more sensitive to acceleration. If the plunger is near the operate or release point, a jar or other acceleration may cause the switch mechanism to snap over prematurely. The effect, then, is that of a shift of operating or release point, narrowing the differential travel (refer to Chapter VI, Section A).

Temperature and Humidity

Fluctuation of temperature and humidity influence operating and release points of a switch by affecting the dimensions of the working parts. Prolonged exposure to high temperature may permanently shift the operating and release points of a switch (refer to Chapter VI, Sections F and M).

Contamination

Splashing an unsealed switch with liquid, or exposing it to steam or other vapors, can cause drastic changes in operating and release points and have other undesirable effects (refer to Chapter VI, Section H).

C. How to stabilize operating and release point in end use

The reasoning outlined in the previous paragraphs leads to the following precautions.

1. Early in the design, get advice about choice of switch from the manufacturer, especially if the application is unusual or performance requirements are critical. It is much easier to build the right switch into the equipment the first time than to change switches after problems appear.
2. Mount the switch against a smooth, flat surface and do not over tighten the mounting screws. If in doubt, consult the switch manufacturer for recommended torque values. When attaching lead wires to switch terminals, avoid excessive soldering temperature or time.
3. Design the actuating device to strike the switch plunger in line with the plunger axis, unless using cam actuation. If a cam is used, choose a switch with the plunger designed as a cam follower. Do not apply excessive force.

4. To stabilize operating point, control the load with the normally open circuit of the switch. To stabilize the release point, control the load with the normally closed circuit of the switch. To stabilize both, minimize current during closure and opening of the switch.
5. If the switch is to be exposed to acceleration, vibration, or shock, orient the switch so that acceleration will not actuate the switch prematurely (refer to Chapter VI, Section A).
6. Minimize changes of temperature and humidity, and avoid exposing the switch to high temperature for prolonged periods (refer to Chapter VI, Sections F and M).
7. Avoid contaminating unprotected switches with water, oil, cleaning compounds or other materials that can affect the dimensional stability of plastics.

So far, the discussion has dealt with ways to keep the operating and release points of switches as stable as possible. Another step would be to design the end use equipment to be as insensitive as possible to normal variation of switch operating characteristics. Finally, test the switch in the end use equipment under conditions simulating those expected in the field. Laboratory measurements of the switch itself, such as those described in this chapter, tell only what the switch will do under the particular conditions that prevailed during the test. A test in end use equipment brings into effect the combinations of mechanical, electrical, and environmental conditions to which the switch will be exposed during use. Then, if everything works satisfactorily, the equipment can be expected to perform as required in the field.

V. SWITCH LIFE

Snap-acting switches are designed for long life. By developing an understanding of the application factors that affect switch life, and applying this knowledge, maximum switch life can be achieved. Without this understanding the user could inadvertently shorten switch life. This chapter explains application factors, and gives guidelines for exploiting the inherent long life of snap-acting switches.

A. The nature of switch life

Switch life is a function of a number of variables in switch design, manufacturing, and end use. A change of any one of these variables can alter the life of the switch. For this reason a switch life figure has meaning only if it is accompanied by a statement of the conditions under which it applies. The application variables that have the greatest effect on switch life are circuit parameters, actuation, the environment, and the failure criteria. Under a given combination of these conditions, however, switch life is not constant. Ten switches of the same kind, tested as nearly identically as possible, are likely to have ten different life figures with a fair amount of spread between highest and lowest. This is because subtle variations in the switch and test conditions have a significant effect on switch life.

When thinking of practical switch life at a given set of conditions, it is best to visualize it as a frequency distribution. If one figure is to represent the life of the switch at these conditions, the figure should be chosen with the distribution in mind. Snap-acting switches are manufactured with close control of materials, dimensions, and adjustments. For satisfactory switch life, it remains up to the end user to select the right switch and to apply it with proper regard to electrical, mechanical, and environmental factors that affect its life.

Just as other components do, switches wear out. However, “failure” of the switch may be subtle, such as a minor drift of the operating point or a reduction in the insulation resistance that renders the switch unfit for further use in a specific application. Failures of this kind must be defined for the particular end use where certain characteristics of the switch are important. There are more obvious modes of switch failure that can affect a wider variety of applications.

Contact Welding

If contacts weld together, the switch may fail to open the circuit reliably. As switch contacts close, they bounce for a few milliseconds. If the electrical load is high enough, the contacts draw an arc as they rebound. This melts metal at the contact surfaces and they close on a pool of molten metal with considerable force. The higher the current, the greater the volume of molten metal.

Most snap-acting switches are designed to stress the weld and cause it to fracture while the switch plunger is still within the differential travel. Welds broken in the normal differential travel have no discernible effect on the performance of the switch. As the plunger approaches the point at which the switch is to open the circuit, contact force decreases and localized heating, together with other factors, may form another weld. The switch mechanism must then break this weld as well. Weld strength varies over a wide range. The tendency of a switch to fail by welding increases with life and with higher current on make and break of the circuit.

Contact Material Migration

In some DC circuits, and occasionally in an AC circuit, a significant amount of contact material migrates gradually from one contact to the mating contact. This produces a mound or cone on one contact face and a corresponding crater in the other. The change of contact geometry may narrow the distance between the open contacts until they can no longer break the DC arc, and the switch is destroyed. In other cases, the cone hooks into the crater and the switch fails to open the circuit. Typical temperatures experienced at the root of the arc as the contacts close are equal to that at the surface of the sun, which can reach temperatures several thousand degrees above centigrade. Naturally, some of the contact material boils vigorously, while some is melted.

During contact bounce on closure, molten metal splashes. As the contacts separate to open the circuit, arcing occurs again. Meanwhile, things are happening on the atomic scale. As the contacts begin to separate, a bridge of molten metal is drawn between them. As it ruptures, it may leave more metal on one contact than on the other. This is called *bridge transfer* and opinions differ as to exactly how it occurs. A short arc is drawn as the bridge breaks. Electrons emitted from the negative terminal (cathode) cross the gap without interference (the gap at this time is too short to contain many gas atoms) and bombard the positive terminal (anode). Their high energy causes ionization of some of the surface atoms of the anode terminal. The resulting positive ions of negative contact material are repelled by the anode and attracted to the cathode. Thus, metal is moved from anode to cathode. As the contacts continue to separate, a phenomenon occurs which moves material in the opposite direction in the form of vapor and continues until the contacts are about 4 microns apart (assuming silver contacts in air).

As the contacts continue to separate, a significant amount of electron avalanching begins and a plasma of ionized gas develops. The gap becomes wide enough to contain an appreciable amount of ambient gas. Electrons emitted by the cathode strike gas atoms, losing some of their energy in the process, ionizing some of the gas atoms and thus releasing more electrons. The electrons reaching the anode have such low energy that ionization of the anode practically stops. Pressure of the metal vapor in front of the cathode is higher than that in front of the anode, and the pressure differential draws a jet of metal vapor from the cathode. The jet strikes the anode and the vapor condenses there. This is called *plasma arc transfer* and causes migration of metal from cathode to anode.

Many other events take place at the contact interface, before, during, and after contact separation, and the entire process may take place in a couple of milliseconds. On the other hand, if the circuit parameters so dictate, arc time may be 50 milliseconds or longer. During contact separation, some processes act to transfer metal from anode to cathode, and others work in the opposite direction. The net effect often is removal of material from one contact, and deposit of part of that material on the opposite contact. If electrical polarity is constant throughout switch life, as it is in most DC applications, the transfer of material during switch life can be considerable. In AC circuits, polarity reverses 120 times per second (in a 60 cycle circuit) and the result may be general erosion of material from both contact surfaces with no buildup on either.

Contact Erosion

In many AC circuits, and some DC circuits, there is a gradual erosion of material from the faces of both contacts. If this proceeds rapidly enough, a contact may be entirely eroded away in the course of switch life. The result can be either failure of the switch to open, or failure to close the circuit.

Dielectric Breakdown

Heating by the electric arc and deposit of eroded contact material can cause an insulator to lose its insulating properties. The result can be a gradual decline of insulation resistance and an increase of leakage current. If the leakage current becomes high enough, it can raise the temperature of the insulator and hasten deterioration. At some point, if the impressed voltage is high enough, the material can break down, destroying the switch. The result is conduction of current through an “open” switch or conduction from the switch terminals to the grounded mounting surfaces.

Mechanical Deterioration

Wear can cause bearings to seize and abrasion particles to accumulate on contacts. Fatigue can cause springs to fracture. Either could cause the switch circuit to fail, open or closed.

Although failure modes have been described individually, two or more may combine. Considerable experience with switch evaluation is needed for accurate identification of the mode(s) of switch failure, but this is an important step in devising ways to increase switch life.

The terms “mechanical life” and “electrical life” sometimes are used in switch evaluation. Mechanical life is the life of the switch without an electrical load. It is determined by such factors as the wear life of bearings and the fatigue life of springs in the switch. Electrical life is the life of a switch controlling a specified electrical load. Electrical life may be limited either by mechanical factors or by the life of contacts or insulators. Neither of these terms is precise. It is much more useful to consider switch life under conditions of actual use, with meaningful criteria of failure.

B. The effects of circuit parameters on switch life

The Current Rating of a Switch

The published current rating of a switch at a given voltage represents the maximum electrical load the switch is designed to control. As a rule it is based on connection of the circuit to either the normally open or normally closed throw of the switch, and does not necessarily apply where both throws of one pole are connected simultaneously. If the switch has more than one pole, the electrical rating usually applies with one throw of each pole connected. The current rating generally assumes that the plunger of the switch is driven to full overtravel and full release during actuation.

Figure 13: Typical curve of switch life versus resistance

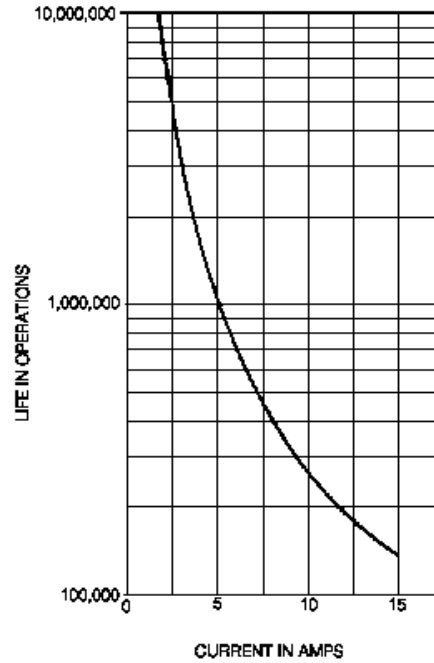

The rated current is only one point on a curve of switch life versus electrical load. For example, a switch having a current rating of 15 amperes at 125 volts AC at room conditions, based on a life of 100,000 operations with 95% survival, can be expected to control currents below 15 amperes satisfactorily. A life-versus-load curve for the switch at these conditions (**Figure 13**) shows the expected life at currents below the rated load. At each condition for which it is rated, the switch can close the circuit, carry the steady-state current indefinitely, and open the circuit, during each cycle of operation through life. The ability of the switch to close and open the circuit reliably is affected by the current-versus-time characteristics of the circuit (**Figure 14**).

Figure 14: Current versus time during switching

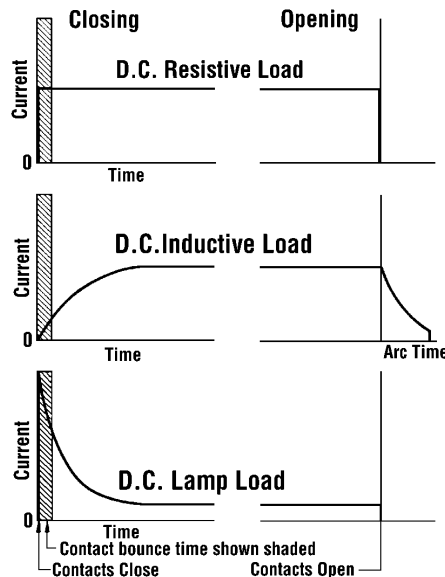

Occasionally the suggestion is made that switches be provided with minimum voltage and current ratings, i.e., values of voltage and current below which they should not be used. This stems from the erroneous impression that a given switch will develop performance problems below specific levels of voltage and current. In practice, this is not the case. A clean switch usually can control microvolt-microampere circuits without difficulty. There is no particular voltage or current level at which problems begin, and there is no technically valid way by which to set minimum electrical ratings. It is possible to establish minimum ratings on the basis of arbitrary resistance levels, but such figures are useless and meaningless for general application. Minimum ratings do not help prevent problems with switch resistance. Furthermore, they may mislead some users into thinking that the switch is satisfactory for any use above the specified current and voltage, without regard to the other variables which affect switch resistance. In short, minimum electrical ratings can increase the cost of switches without a corresponding increase in performance.

Closing the Circuit

In a DC resistive circuit such as an electric heater, the steady-state current is present at the instant of switch closure. As the switch contacts strike and then bounce apart, each rebound draws an electric arc. This melts metal on the surfaces of the contacts, and some of the metal is evaporated. There may be some general erosion of material from both contacts, and a net transfer of material from one to the other. The contacts then close on molten metal, sometimes forming a weld when the metal freezes. The higher the current the stronger the weld is likely to be, and the higher the force that the switch mechanism will have to provide to open the circuit. The strongest welds occur when the load is characterized by a high inrush current, such as that of a motor, a tungsten-filament lamp, or with many capacitive type circuits. In the case of a lamp, the inrush current may be ten or more times as high as the steady-state current. If the inrush current persists during part or all of the contact bounce time, conditions are conducive to severe arcing and strong welds. The highest current of all occurs when the switch is closed on a short circuit. Unless the switch is specially designed to withstand closure on a short circuit, the switch life can be predicted to be zero.

In a DC inductive circuit there is a time delay, as the magnetic field builds up in the coil, before current reaches its steady-state level. Since most of the contact bouncing occurs during the low-current part of the transient, there is little contact deterioration and almost no tendency to weld during closure. In AC circuits the switch closure occurs at random points along the current sine wave curve, which includes peak and zero current. AC inductive circuits, such as those containing solenoid coils, almost always involve moving an iron mass, which consequently causes large inrush currents.

Switches are designed to resist contact deterioration and the effects of contact welding; however, lower currents levels during the closing and opening of the contacts will increase switch life.

Carrying the Steady-State Current

Once the contacts have closed and stabilized, the switch carries the steady-state current of the circuit. This is simply a matter of controlling the I^2R heating, and seldom presents a problem. One ampere AC has the same heating effect as 1 ampere DC, since the equivalence of the two is based on heating. Control bodies such as Underwriters Laboratories may impose limitations on temperature rise at rated current, but the requirements usually are easily met.

If a switch is used in calibrated thermostatic equipment, there may be practical limits on the heat the switch is permitted to dissipate. Except for very unusual overloads or short circuit conditions, however, switch life is unaffected by the current the closed switch carries.

Opening the Circuit

Before the contacts can separate, any welds holding them together must be fractured by the switch mechanism. Switches are designed to do this. In a DC resistive circuit, the steady-state current is present at the instant of switch opening. When the contacts of the switch separate far enough to extinguish the arc, nothing further happens. Arc time in a DC resistive circuit usually is very short and arc energy is low.

There is some erosion and migration of contact material. In a DC inductive circuit, arcing is more severe, because the energy stored in the magnetic field of the coil is partially dissipated in the arc as the field collapses. The arc often persists after the contacts are fully separated, and contact erosion and migration continue as long as the arc lasts. During the life of the switch, migration gradually narrows the space between the open contacts and eventually may draw and sustain an arc, destroying the switch.

Normal arcing melts and evaporates contact material, some of which may condense on surfaces of adjacent insulators. The intense heat of the arc itself may gradually deteriorate insulators that are near it. The general effect is to reduce their insulation resistance and dielectric strength. This is encouraged in a DC inductive circuit by the voltage transient that occurs just as the arc goes out. The current drops suddenly to zero, producing a voltage proportional to its rate of change. The duration of this high voltage transient usually is so short that it has little effect on switch life. Switches are designed to withstand these conditions during life, but at the end of switch life, one possible mode of failure is electrical breakdown of an insulator. The higher the source voltage, the more prevalent is this mode of switch failure.

Because DC inductive loads produce the most arcing, they are associated with another phenomenon. An unsealed switch exposes the electric arc to air, producing chemically unstable oxides of nitrogen and nitric acid if the air is humid. Normally this is so diluted by the air that it causes no problem, but if the air is very humid, enough HNO_3 may be dissolved in the water vapor to cause internal corrosion of the switch. Remedies will be discussed later. DC motor circuits are no problem for the switch to open unless stalled rotor conditions prevail.

As a rule, AC circuits are easy for the switch to open because the arc is extinguished as the current passes through zero. At very high electrical frequencies (over 1000 Hz) the atmosphere between the contacts may not have time to deionize and the voltage may restrike the arc, but such situations are rare. In general, when opening the circuit, anything that reduces arc energy will increase switch life.

Connection of opposite polarities between normally open and normally closed terminals of a switch can cause early failure. The electric arc is a conductor that bridges the gap between the opening contacts of the switch. The arc may be extinguished while the contacts are separating, or may persist for a few milliseconds after the contacts are completely open. This is normal, and switches are designed for it. A condition for which they are not designed occurs when opposite sides of the line are connected respectively to the normally open and normally closed terminals of the same pole of the switch. When this is done, and when the arc persists after the contacts are fully apart, a short circuit is established through the arc and, hence, through the switch.

This drastically reduces switch life and is a condition to be avoided. A connection of this kind can occur unintentionally. **Figure 15** shows two circuits illustrating the principle.

Figure 15: Connection of opposite polarity between normally open and normally closed terminals, causing early failure

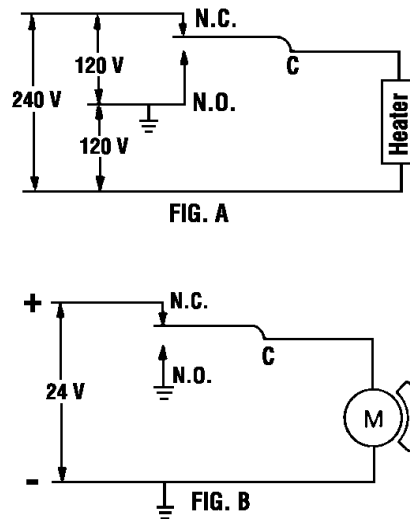

In the circuit of **Figure 15 (A)**, a double throw switch is used in a conventional single phase, three-wire installation, with the center wire grounded. This provides 240 volts AC between outside conductors and 120 volts AC between either of the outside conductors and the center conductor. The switch is intended to change a heater from “high” heat (240 volts) to “low” heat (120 volts). Current values are 10 and 5 amperes, respectively. However, arc duration exceeds the transfer time of the switch, and an arc is drawn between normally open and normally closed contacts. This provides a short circuit through the arc with an impressed voltage of 120 volts. The switch fails after a few operations. In the circuit of **Figure 15 (B)**, a 24 volt DC permanent magnet motor is connected to permit dynamic braking. Although the motor draws only 1.5 amperes, a short circuit occurs through the arc as soon the contacts are fully apart, and the switch fails immediately.

C. The effects of actuation on switch life

Actuating a snap-acting switch involves several factors that affect switch life: direction, distance, force, velocity, and frequency.

Direction of Actuation

If the switch has a plunger actuator, longest life is obtained by depressing the plunger with an actuating member that moves along the same axis as the plunger. The surface striking the plunger should be perpendicular to the plunger axis to avoid side thrust that causes unnecessary wear on switch bearings. Actuating force applied at an angle to the plunger axis will have a component perpendicular to the sliding bearing surface of the plunger. If the actuator movement is coaxial with the switch plunger, the extra bearing wear is eliminated. Some side movement can be tolerated.

In many cases side thrust cannot be avoided, and switches are designed to withstand a certain amount of it. But over many thousands of operations, the effects of side thrust are detrimental to switch life. If side thrust cannot be avoided, use a roller plunger actuated switch, i.e., one having a roller on the plunger. A lever or roller lever is also a possibility, especially for cam actuation.

Distance of Actuator Travel

In many switch applications, the distance the actuating member moves is determined by the operating point of the switch. An example is a limit switch that stops movement of a sliding machine carriage at a certain point. In some applications, however, the amount of travel applied to the switch plunger is optional and controllable. In such cases, the plunger must receive enough travel to assure that the switch will operate properly, but additional travel may tend to reduce switch life. This is simply a matter of the amount of bending applied to the internal spring system of the switch. The farther the switch plunger is depressed or released, the higher will be the stresses in the spring and the shorter the life. All switches can tolerate a certain amount of overtravel (i.e., plunger travel beyond the operating point) and some are provided with special mechanisms that allow a very long overtravel without damage. But for longest switch life, unnecessarily long overtravel and release travel should be avoided.

Force Applied to Switch Plunger

With any switch, a certain force is necessary to depress the plunger to the end of its travel, i.e., the full overtravel point. Most switches are designed to tolerate additional force, and figures of maximum allowable actuating force are available from switch manufacturers. If this force is exceeded, the mechanical life of the switch can be reduced drastically. An example of misapplication of this kind is the use of the switch as a mechanical stop to limit the travel of a moving member. Dynamic loads can have disproportionately high static equivalents. It is essential that the force applied to the switch plunger not exceed the design limit of the switch.

Velocity of Actuating Member

An actuating member striking or releasing the plunger with high velocity delivers a shock to the mechanism of the switch. This can cause high stresses, multiple flexings of the spring and considerably more bouncing of the contacts. Extreme forms of this are referred to as “impact” actuation or “drop-off” release and are noted for their tendency to reduce switch life. A logical question is: how high can actuating velocity be, without reducing switch life significantly? This depends largely upon the design of the switch and the nature of the electrical load, but an actuator velocity of 5 inches per second usually causes no trouble and much higher velocities often can be tolerated. If long life is desired in an application involving high velocity actuation, the switch manufacturer can help select a suitable switch, and some thought might be given to actuation through a velocity reducing linkage. In rare cases, acceleration of the actuator must also be considered, but this requires individual treatment by the switch manufacturer.

Frequency of Switch Actuation

If the switch mechanism is still in motion from prior actuation when it is actuated a second time, dynamic effects can cause high spring stresses and reduce the life of the switch. High frequency actuation can aggravate contact bouncing and hasten the deterioration of contacts.

For satisfactory switch life, the bulk temperature of the contacts must be controlled by the design of the switch. Switches are designed with adequate heat sinks for normal requirements, but with heavy electrical loads, high-frequency actuation of the switch can overheat the contacts and reduce switch life. Again, limiting values of frequency of actuation depend upon the design of the switch, the electrical load, and performance requirements of the circuit. But some representative figures are useful.

It is common to establish the electrical ratings of snap-acting switches at full travel of the switch plunger with an actuating frequency of 60 operations per minute for AC loads and 20 operations per minute for DC (shorter inherent arc time of AC permits the difference). With actuation above these frequencies at full rated electrical load, it would be reasonable to expect some reduction of switch life. At lower current, higher frequencies of actuation can be tolerated. At the other end of the spectrum, mechanical endurance tests of switches with no (or negligible) electrical load are commonly performed with actuating frequencies from 100 to 800 operations per minute, depending upon the design of the particular switch. The switch manufacturer is the best source of advice on frequency of actuation.

D. The effects of environment on switch life

Life figures and current ratings for general purpose switches are established at room conditions and are valid for the various combinations of temperature and barometric pressure associated with living areas. The most common deviations from room conditions, that may tend to reduce switch life, are reduction of atmospheric pressure and increase of ambient temperature. As atmospheric pressure is reduced (in high-flying aircraft, for example), an unsealed switch will experience an increase of arc energy and a slight reduction of dielectric properties. Under some conditions, it may be necessary to reduce the current rating to maintain the same switch life. Published current ratings often reflect this fact. A simple way to maintain switch life in a vacuum without reducing the current is to use a sealed switch.

Ambient temperatures above that for which the switch is design can reduce insulation resistance and dielectric properties of plastics, reduce the elastic modulus of the spring material, and interfere with efficient cooling of the contacts. The result can be reduced switch life, or the necessity to reduce the current to maintain the desired switch life (see Chapter VI, Section M). Specific questions about switch life at high temperature are best handled by consulting the switch manufacturer. To assure adequate switch life, it is wise to test the switch under conditions simulating those of end use.

E. Evaluating and estimating switch life

When are Life Tests Needed?

In most switch applications the electrical, mechanical and environmental conditions, and requirements are known to be well within the switch's capability, and no special testing of the switch is required. There are cases, however, when evaluation of the switch is needed. A critical application, such as one in a manned space vehicle, may require that numerical life figures be established for reliability purposes. Similar data may be needed as a basis for preventive maintenance in production machinery. An unusual condition or requirement of end use may dictate need for a life test.

Control of Life Test Conditions

Subtle differences between test conditions and those of end use can invalidate a test. The effect is to render the test not only useless but hazardous, since inadequate switches may pass the test but fail in end use. When need for a test arises, time and money can be saved, and the tests rendered more useful, if the major variables are specified and controlled, as they are in a switch testing laboratory. In order to be useful, a test must be both valid and reproducible. A valid test is one that measures what it is intended to measure. A reproducible test is one that gives essentially the same results on identical test specimens. The test must be carefully designed to reflect the electrical, mechanical, and environmental conditions of end use. The criteria of switch failure must be based upon actual performance requirements of the application. The switch performance criteria must be accurately monitored during the life test. The following test conditions are the considered most important:

- Mounting surface - electrically conductive or insulating.
- Mounting means - panel mount, side mount, bolts, adhesive, etc.
- Attitude of switch.
- Mass and elastic properties of actuating member.
- Direction of actuation with respect to the switch.
- Overtravel and release travel applied to the switch.
- Overtravel force applied to the switch.
- Velocity of actuating member.
- Frequency of actuation, and on time versus off time.
- Wire gage and means of attachment of wires to switch.
- Location of electrical ground points in the circuit, including grounding of power supply, switch mounting and actuating member.
- Polarity of connection to switch.
- Connection of switch in hot or ground side of line.
- Connection of poles and throws of the switch.
- Voltage magnitude and tolerances.
- Current magnitude and tolerances on make, carry and break.
- Frequency of alternating current.
- Inductive or capacitive characteristics of circuit (when testing, use actual load components of end use, if possible).
- Temperature.
- Atmospheric pressure.
- Relative humidity.
- Definition of switch failure or endpoint of the test.
- Instrumentation used to detect switch failure.

Switch Failure Criteria

Most of the variables in the previous list are tangible and fairly obvious, although several are frequently overlooked. Definition of “switch failure” requires some clarification. If a switch is to control a critical circuit in a surgical instrument, a single malfunction of the switch may have serious consequences. A switch in the scoring circuit of a pinball machine may suffer repeated malfunctions and not be noticed, or cause nothing more than a minor inconvenience. So the first consideration in deciding criteria of failure is the seriousness of a single malfunction. Bear in mind that the malfunction may take the form of either failure to open or to close the circuit. Next, how many malfunctions can be tolerated? Is the total number important, or is it the frequency of occurrence that should determine end of switch life? What if the switch experiences several malfunctions in succession, then reverts to correct operation? What if malfunctions occur singly and only occasionally, perhaps at the rate of 10 in 1000 operations?

The criteria of switch failure are set on the basis of answers to these questions. A very conservative criterion may be set by deciding that the first failure of the switch to open and close the circuit once, and only once, for each cycle of the actuating member constitutes end of switch life. In some circumstances, such a stringent criterion is justified. In many cases, however, a switch has considerable useful life remaining after the first malfunction, and a conservative definition of failure can be unnecessarily expensive. It may be more realistic and economical to set the endpoint of the life test in terms of X malfunctions per thousand operations, or a continuous sequence of Y malfunctions. The important thing is that the criteria of failure be significant, pertinent to end use, and clearly defined. The equipment used to monitor switch performance during the test must then be chosen with these criteria in mind.

Sample Size for Life Test

How many switches should be tested? Unless the distribution of switch life is already known, this question cannot be answered before the test. Since the purpose of the test usually is to establish the shape and dimensions of the life distribution curve, the size of the initial sample is a matter of intuitive judgment. It is unsafe to assume that the life of a particular switch follows a normal, exponential, or other particular distribution, unless it has been demonstrated to do so by life tests. The sample must be large enough to be able to show the range of life which is characteristic of the switch under the conditions of test. In the absence of other guidelines, a good initial sample is 10 switches. Statistical treatment of the resulting life figures may show that this is sufficient, or may indicate need for tests of additional samples to define the distribution more accurately.

Combining Tests

In the interests of efficiency and economy, it is not unusual for switch test specifications to call for several tests in sequence on one switch. If the tests preceding the life test are simply measurements that do not damage the switch, this is a good idea. If they degrade the switch, however, the subsequent life test may not be valid. Sometimes a test sequence is set up to “condition” the switch, i.e., intentionally render it more susceptible to failure during a subsequent life test. Unless the nature, severity, and sequence of such preparatory conditions accurately reflect those of end use, the life test will be difficult to interpret in realistic terms.

Post Mortem Examination of the Switch

A switch may be examined after failure either in end use or on a life test, and if the examination is properly performed, it can yield a great deal of useful information. The switch must be opened without destroying important evidence. The condition of the switch must be accurately observed and described, and the mode(s) of failure must be clearly determined. Any irregularity or unforeseen performance of the switch during its life must be accounted for during the examination. The x-ray and the microscope are important tools for this purpose.

Having ascertained the condition of the switch and related this to its performance during life, one must then decide what implications this has for application of the switch in end use. An experienced eye is needed to perform this examination properly, and the best source of help is the switch manufacturer. To get the most useful information, do not open the switch. Pack it in a plastic bag to keep out contaminants, and return it to the manufacturer with a full description of its history and performance. Include information on the environment, actuation, voltage, current, and frequency of actuation. Tell which throw of the switch controlled the load, and whether the switch failed to close or failed to open the circuit. Complete information supplied with the returned switch will enable the manufacturer to make a speedy and conclusive analysis of the problem and to recommend a practical solution.

Interpretation of Life Test Results

Given the results of a life test of a sample group of switches, which of the life figures is to be considered the one that best represents the life of this kind of switch? It is common practice to arrange the figures in order of magnitude, “eyeball” them and make an educated guess. This is perfectly acceptable for many applications. Intuition is a fairly good guide, provided that the guess is truly an educated one and is based on an adequate and representative sample. Many statistical techniques have been applied to switch life figures, with varying degrees of success. Some of the unsuccessful attempts have assumed that the life figures were distributed in accordance with a Gaussian or other standard curve, and have tried to force-fit data to the curve. Such estimates have no practical value and may even be hazardous if trusted too far.

The best statistical treatment of switch life data is based on the Weibull equation. The equation has three parameters which, when varied appropriately, enable the curve to be adjusted to fit a wide variety of distributions. A computer program uses switch life figures to do the following:

- Arrange figures in order of magnitude and print.
- Determine Weibull parameters which best fit the curve to the distribution, and print them. For convenience, the location parameter is logically assumed to be zero.
- Print life figures corresponding to preselected probability levels, 90%, 95%, 99%, 99.9%, etc.
- Print probability levels corresponding to preselected life figures, giving expected percent survival at each figure.
- Plot curves of frequency distribution and cumulative distribution, based on the curve fitted to the data.

Thus, quantitative estimates of switch life can readily be made. One conclusion drawn from studying many test results analyzed by this method is that all switch life figures do not tend to follow any single type of distribution. It is a mistake to assume, without testing, that switch life tends to follow a normal, log-normal, or any other predetermined distribution.

Figure 16: Weibull analysis of switch life figures

PERSON IN CHARGE	PROBLEM	WEIBULL	
TYPE AND SWITCH	MECHANICAL LIFE	PERCENT	
NUMBER OF KNOWN SAMPLE VALUES	IN	TOTAL=TOTAL NUMBER OF SAMPLE VALUES	
N (SAMPLE VALUES)			
124000	448000	675000	
934000	974000	1370000	
1327000	1493000	1578000	
2713000		1693000	
		2290000	
		3284000	
		3747000	
SHAPE PARAMETER C = 2.43229			
SCALE PARAMETER B = 1372442.77950			
MEAN = 1217501.68137			
MEDIAN = 1489371.21783			
STANDARD DEVIATION = 532741.03123			
FRACTION OF THE TOTAL THAT EXCEEDS 100000 = .99829			
FRACTION OF THE TOTAL THAT EXCEEDS 130000 = .99543			
FRACTION OF THE TOTAL THAT EXCEEDS 200000 = .99062			
FRACTION OF THE TOTAL THAT EXCEEDS 300000 = .97551			
FRACTION OF THE TOTAL THAT EXCEEDS 500000 = .91781			
.60000 IS THE FRACTION OF THE TOTAL THAT EXCEEDS 544323.71787			
.40000 IS THE FRACTION OF THE TOTAL THAT EXCEEDS 68842.91895			
.30000 IS THE FRACTION OF THE TOTAL THAT EXCEEDS 25609.21740			
.20000 IS THE FRACTION OF THE TOTAL THAT EXCEEDS 20715.01862			
.10000 IS THE FRACTION OF THE TOTAL THAT EXCEEDS 80233.18936			
N	F(x)	F(x) N	F(x)
100000	.00171	100000	.00171
130000	.00329	130000	.00329
200000	.00671	200000	.00671
300000	.01329	300000	.01329
500000	.03671	500000	.03671
1000000	.08329	1000000	.08329
1300000	.11671	1300000	.11671
2000000	.18329	2000000	.18329
3000000	.26671	3000000	.26671
5000000	.43329	5000000	.43329
10000000	.73671	10000000	.73671
13000000	.88329	13000000	.88329
20000000	.98671	20000000	.98671
30000000	.99671	30000000	.99671
50000000	.99929	50000000	.99929
100000000	.99971	100000000	.99971
130000000	.99983	130000000	.99983
200000000	.99997	200000000	.99997
300000000	.99999	300000000	.99999
500000000	.99999	500000000	.99999

Figure 17: Distribution curve (based on analysis in Figure 16)

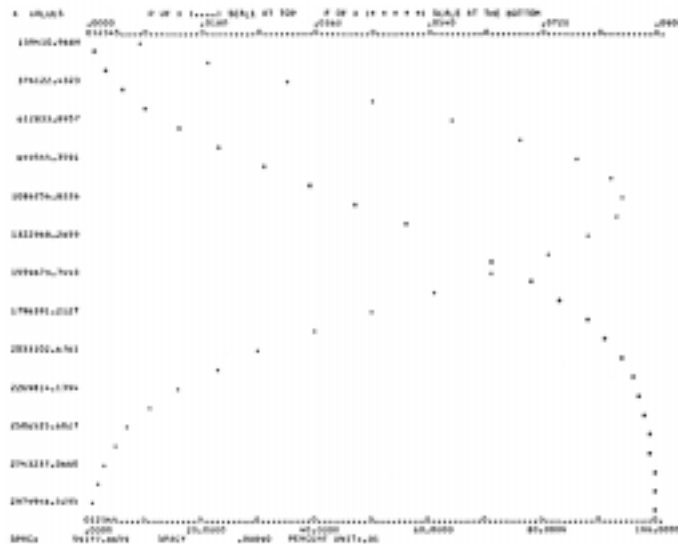

F. How to increase switch life in end use

Given that a snap-acting switch is designed for long life, what can the user do to take maximum advantage of this feature? The variables of end use can be classified under the headings of electrical, mechanical, and environmental factors. Several ways to prolong switch life are described below:

Electrical Factors

Voltage: In some instances where a switch is used to control a 480 volt AC load, the circuit can be arranged so that the switch performs the required function but controls only 120 volts.

Usually, contact life of a switch is about the same at 240 as at 120 volts AC, and is only somewhat reduced at 480 volts. The probability of dielectric breakdown, however, increases with the supply voltage, and switch life is appreciably longer at lower voltages.

Current: As a rule, the lower the current, the longer the switch life. Therefore, reducing the current that the switch must close and/or open usually increases the life of the switch. There are exceptions, such as cases where spring life is the limiting factor, or where the rate and direction of contact material migration must be controlled. Circuits having high inrush current may limit switch life by contact erosion or welding. If the inrush is due to tungsten filament lamps or vacuum tubes, a resistor can be connected in parallel with the switch to keep the filaments warm and reduce the inrush current. This, of course, draws some current when the switch is open. If this is objectionable, a resistor or thermistor in series with the filament can reduce inrush current.

Arc Control: The less severe the arc, the longer the life of the switch contacts. The most severe arcing usually is encountered in DC inductive circuits. Here the energy stored in the field is partially dissipated in the arc. Several arc suppression techniques are available. One of the simplest and most effective is a diode connected in a blocking mode across the DC coil. When the switch opens, the polarity of the voltage induced in the coil opposes that of the steady state condition and the diode conducts, shorting the coil. This can greatly reduce arc energy at the switch contacts and give a corresponding increase of switch life. The diode can be of much lower current capacity than the steady state current of the load, because the diode conducts only for an extremely short time. The diode should have a peak inverse voltage rating exceeding the source voltage. Use of a diode will delay drop out time of the inductive device by a few milliseconds, but this usually is acceptable. The arc suppression device should be tested to confirm its suitability. Reducing the arcing in this way can extend switch life greatly by reducing the rate of contact material migration and decreasing the heat dissipated by the arc.

Choice of Throw: The normally closed throw of a snap-acting switch usually is better able to break contact welds than is the normally open, because of the nature of the switch mechanism. If a circuit has high inrush current on closure or requires the switch to open current near its rated load, switch life is likely to be longer if the normally closed throw is used to control the circuit.

Grounding: Switches often are mounted on a surface or bracket that is electrically grounded. In many cases this is desirable or necessary for safety. In others, it is optional. If the mounting is connected to a common electrical ground with the power supply, line voltage will be maintained between current carrying parts of the switch and the mounting surface. This applies a continuous electrical stress and acts to encourage dielectric breakdown as switch life proceeds.

The electrical ratings of switches are established with the mounting grounded, to provide “worst-case” conditions. However, if the switch is mounted on an insulator in end use, and actuated with an insulating member, the life of insulating parts of the switch will be prolonged.

Mechanical Factors

- Actuate the switch coaxially with the plunger, if possible. If not, use a roller plunger or roller lever type switch to prolong the life of the plunger bearings.
- Avoid impact actuation and drop-off or snap release of the switch plunger.
- Life of the switch mechanism can be increased by reducing the travel of the plunger, but if current is high, do not reduce plunger travel to the point where contact welding becomes a problem. If life of the switch is limited by contact welding, drive the plunger to full overtravel and full release.
- Do not apply excessive force to the plunger at full overtravel.
- If heavy electrical loads are to be controlled by the switch, frequency of actuation should be no higher than 20 operations per minute on DC loads, or 60 operations per minute on AC.

Design of Cams for Switch Actuation

Many switches are designed for actuation by rotating or reciprocating cams. Cam actuation of switches usually is easily arranged and seldom presents problems. To get the longest possible switch life with cam actuation, here are some factors to consider. Mechanically, the switch and its roller plunger or roller lever constitute a spring loaded cam follower. The common principles of cam design and follower positioning apply. Cams used for this purpose should be designed to minimize wear, force, and impact. When a switch roller bears against a cam face, wear is governed by such factors as position and motion of the switch plunger or lever with respect to the cam, the applied force, cam surface speed, profile, material, finish, and lubrication. High velocity cam movement against the switch roller can accelerate wear of both the cam and the roller. Misalignment of the roller with the cam increases wear (see **Figure 18**). The cam and roller should lie in the same plane. An ideal cam profile would be designed so that the roller contacts the cam at all times. To reduce wear at low cam speeds, constant acceleration or simple harmonic curves can be used. At higher cam speeds, changes of acceleration with respect to time can be reduced with cycloidal curves.

Figure 18: Installation of cam actuated switches

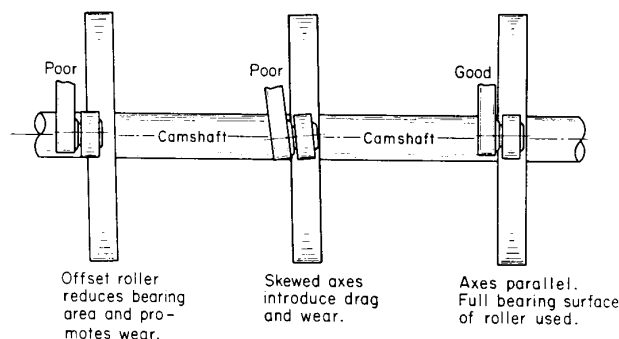

As a rule, with roller actuated switches, cam rise angle should not exceed 30° and drop-off release should be avoided (See **Figure 19**). Impact between the cam and roller tends to promote wear and loosen the follower on its bearing. Depressing and/or releasing the switch actuator at high velocities may reduce the spring life. In an extreme case of the latter, the cam can pull away from the roller before the switch plunger is fully released. Plunger travel then stops abruptly when the roller again strikes the cam, or the mechanism of the plunger strikes its internal stops. The result is reduced switch life. In some lever type switches designed for actuation in either direction, the lever may oscillate after drop-off release, giving a series of false operations with added wear and spring fatigue.

Figure 19: Cam design for switch actuation

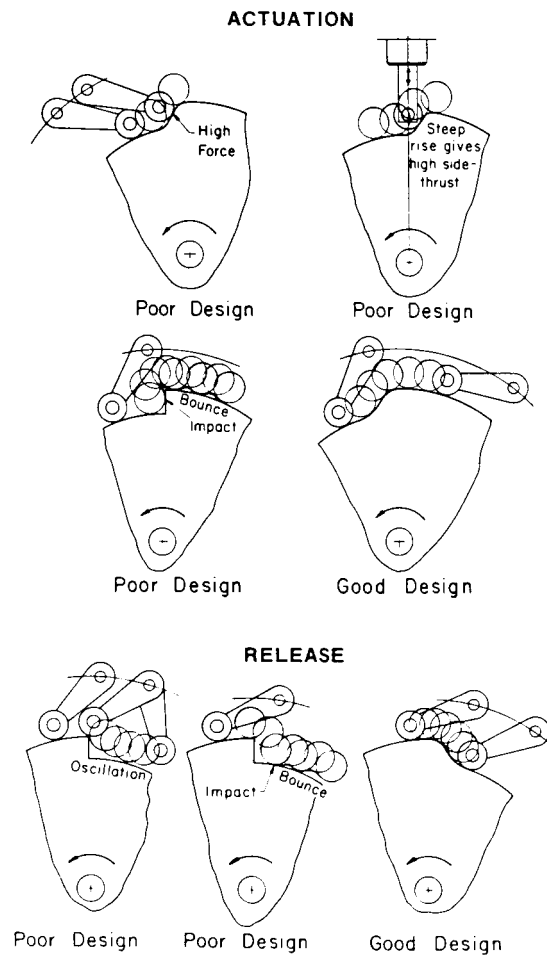

In studying the effect of cam profile on switch actuation, a stroboscope is often helpful. Excessive force applied by the cam at full plunger overtravel can reduce switch life (see **Figure 20**). Questions regarding cam material, finish, and lubrication generally are resolved by trial. Lubrication of the cam may require that the switch be sealed to avoid contamination. In testing switches designed for cam actuation, one switch manufacturer effectively uses test cams which are eccentric circles of one-foot circumference. The cams are made from Stentor tool steel, hardened to 60-62 Rockwell C. The amount of eccentricity is specified to give the switch actuator the desired travel. A common rate of cam rotation for test purposes, where electrical load is negligible, is 200 RPM. This, of course, causes the roller to travel 200 surface feet per minute.

Figure 20: Cam design to avoid impact actuation

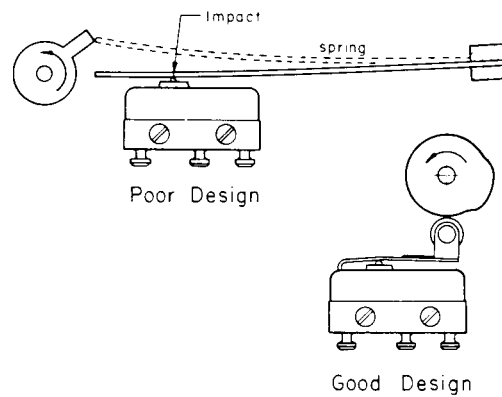

Environmental Factors

A switch designed primarily for service at room conditions will provide longest life at those conditions. If the application involves a considerably different environment, a switch should be chosen with that in mind. The switch manufacturer is the best source of advice in making this choice. To provide the most favorable environment from the standpoint of switch life:

- Avoid operating the switch in a vacuum.
- Keep the ambient temperature below 100°F (37°C).
- Keep humidity low.
- Avoid contaminating unsealed switches.

Chapter VI provides more information on the effect of environment on switch life.

G. Preventive maintenance

Although snap-acting switches are designed for long life, and prudent application takes advantage of this fact, no switch is eternal. If actuated through enough cycles, any switch will eventually wear out. This may result in failure to open a circuit or failure to close it. The malfunction may be intermittent or continuous, and its onset may be gradual or sudden.

The way the switch is applied determines how serious a matter its failure can be. Shutdown of a production line, for example, can be expensive and can justify considerable effort to avoid it. If failure of a switch can have serious consequences, it is especially important that the right switch be chosen for the application, and it should be replaced at appropriate intervals to avoid failure due to wear. A switch subjected to contamination in end use should be of sealed construction. If a switch is unsealed it should be kept as clean and dry as possible. Oil spills or dust accumulation should be avoided. Watch for deterioration of the drive linkage that may apply excessive side thrust to the switch plunger. Standard switches are not designed to be used as part of a safety system. For example, a switch used on a safety gate guarding a punch press should be designed specifically for safety applications, and applied following appropriate safety standards, regulations, and directives.

If a switch malfunction occurs in a critical application, replace the switch immediately. Do not assume that all is well because the malfunction occurred only once. If the cause of the malfunction cannot be determined, return the switch unopened in a plastic bag to the manufacturer for failure analysis and recommendations. Opening the switch can destroy important evidence needed for an accurate analysis of the switch failure. In discussing switch performance with the manufacturer, the major variables listed in Chapter V, Section E, are of prime importance. A full description of the conditions of end use enables the manufacturer to recommend ways to increase switch life. The experience of the switch manufacturer is helpful in setting up preventive maintenance programs. Often statistical estimates of switch life can be supplied, along with other valuable advice to reduce machine downtime.

VI. APPLYING SWITCHES IN HOSTILE ENVIRONMENTS

In their simplest forms, electromechanical, electromagnetic and solid state control devices are designed for environments which may be called friendly, i.e., clean factory areas, offices, and other surroundings that are typical of room conditions. However, these devices often are needed for use in the presence of dust, dirt, metal particles, oil, corrosive agents, or for very high or low temperatures. For extreme environments such components usually are made from special materials, provided with protective enclosures, or are changed in other ways to alter the immediate area of control and enable the device to survive and perform satisfactorily.

Snap-acting switches control circuits safely and reliably in millions of applications. As the link between the mechanical and electrical parts of a system, a switch must perform well, both mechanically and electrically. It usually does, despite the complicating effects of temperature, humidity, and other environmental factors. Still, there are environments that reduce the reliability of switches and can even cause premature failure. High temperatures can reduce contact life; a partial vacuum can encourage electrical breakdown to ground; oil can deteriorate plastics and disable the switch; ice may jam the actuating mechanism; the electric arc in an unsealed switch can detonate an explosive atmosphere.

The effects of the environment on a switch is not always obvious, and it is possible for a system design to be well advanced before a potential switch problem is recognized. Familiarity with the effects of environment on switch performance often can improve the design and save considerable time. This chapter discusses the factors to consider when applying switches in hostile environments.

Switch electrical ratings are shown in manufacturers' catalogs and often are printed on the side of the switch, but environments are much more difficult to classify. Any specific environment consists of a unique combination of temperature, pressure, humidity, contamination and the like, and these conditions sometimes conspire to cause switch problems. The environment in which a switch must operate is determined not only by the geographical location but also by the equipment and circumstances in which it is to be used. A switch may be operating in an arctic oil drilling installation but in a heated cabin where it is never expected to function in extreme cold. On the other hand, a switch in the tropics, in the temperature control system of a refrigeration unit, may be exposed continuously to cold. The temperate climate of the central Atlantic Ocean imposes no undue stress on switches, aside from the humidity and corrosive effects of the marine environment. However, switches on aircraft flying above this area may experience -65°F (-54°C) on the landing gear or 1000°F (537°C) near the afterburner, both in a partial vacuum. Switches below the ocean surface on submarines and stationary undersea equipment are exposed to high hydrostatic pressure. On land, switches in sump pumps, flour mills, and redi-mix concrete trucks are exposed to contaminants, while those in paint spray equipment, printing presses, and surgical operating rooms may constitute an explosion hazard.

When choosing a snap-acting switch for use in an adverse environment, the selection must be based on the required performance and the conditions of end use. The switch manufacturer is the best source of advice. The switch should be tested by exposing it to simulated conditions of end use (electrical, mechanical, and environmental) and evaluating it to be sure it performs as required. Following are some guidelines for environments often encountered.

Typical Hostile Environments for Precision Switches

High Temperature

Industrial and household furnaces, pasteurizing equipment, steam cleaning of food processing machinery, foundries, rolling mills, surfaces of high performance aircraft, jet engine afterburners, and missile launchers.

Low Temperature

Commercial refrigeration, military and commercial equipment in arctic regions, aircraft flying above 35,000 ft., cryosurgical, liquid oxygen and other cryogenic equipment.

Temperature Shock

Transfer of equipment to and from heated shelters in arctic regions, airdrops of military supplies, spacecraft reentry.

Vacuum

Aircraft and spacecraft, aerial cameras and weather instruments, and industrial vacuum processes.

High Pressure

Undersea equipment, and oil drilling instrumentation.

Humidity

Laundry machinery, dairy and meat packing equipment, textile plants, hothouses, carrier based aircraft, and pharmaceutical manufacture.

Liquid Splash or Shallow Immersion

Sump pumps, aircraft landing gear, shipboard deck mounted equipment, gasoline pumps, and hydraulic production machinery.

Ice

Snow removal machinery, ski lifts, refrigeration controls, aircraft, and arctic installations.

Corrosion

Marine and seaboard applications, plating departments, and battery manufacture.

Sand or Dust

Earth moving machinery, desert vehicles, air conditioners, foundries, cement mills, concrete block manufacture, textile manufacture, and flour mills.

Fungus

Tropical military gear, geological and meteorological instruments.

Explosion

Starch packaging, coal mines, petroleum refining, grain elevators, flour mills, coke manufacture, surgical operating rooms, and machining operations producing aluminum or magnesium dust.

A. Acceleration, shock and vibration

A well kept secret of World War II was the design of the Norden bombsight. To keep it from falling into enemy hands, the top secret bombsight was rigged with an explosive charge to be detonated automatically by a shock actuated switch assembly if the bomber should crash. The assembly had been carefully and logically designed. The actuating mechanism for the snap-acting switch was carefully adjusted to respond to the abrupt deceleration of a crash, but not to the buffeting of rough weather or the impact of a hard landing. Experience had shown that the snap-acting switch was unaffected by the vibration and shock usually experienced by military aircraft. When the assembly was ready, a technician installed it in the bombsight of an operational bomber. He climbed out of the plane and slammed the door. When his ears stopped ringing, he turned to survey the scattered debris of what had once been a bombsight. Study showed that neither the switch nor the actuating mechanism would have responded to the shock of the slamming door, but the combination did, since the shock sensing mechanism held the plunger of the switch depressed almost to the operating point. This reduced the contact force and the jar of the slamming door actuated the switch. The remedy was simple: Keep the plunger fully released instead of partially depressed.

Before considering the effects of acceleration, shock, and vibration on precision switches, it is important to have the nature of these environments well in mind. Since shock and vibration are forms of acceleration, the first consideration is the nature of acceleration. When an automobile travels along a straight road at constant speed, its velocity has two characteristics: magnitude (30 miles per hour), and direction (northeast). Velocity always is characterized by magnitude and direction. The magnitude of velocity can be changed by speeding up or slowing down. The direction of velocity can be changed by changing the direction of motion. The direction of the velocity is always the same as that of the motion. Acceleration is any change of either the magnitude or the direction of velocity.

If the automobile is coasting along a straight road, then (neglecting friction and windage) its velocity is constant and its acceleration is zero. If the automobile speeds up, thereby increasing the magnitude of its velocity, it is accelerated in the same direction as its velocity. If the automobile slows down, thereby decreasing the magnitude of its velocity, it is accelerated in the direction opposite to that of its velocity. If the magnitude of velocity (i.e., the speed) remains the same (say 30 miles per hour), but the direction of motion changes, the direction of velocity changes with it, and this also constitutes an acceleration. If the automobile rounds a curve toward the right, while maintaining constant forward speed, its acceleration due to change of direction of velocity is toward the right, specifically toward the center of curvature of the curve itself.

Similarly, a turn toward the left, at constant speed, involves acceleration toward the left. If both speed and direction are changing at the same time, the total acceleration is the vector sum of the components of acceleration due to change of magnitude of velocity, and the change of direction of the velocity.

Now consider the effects on a passenger in the automobile during acceleration. In all instances, the passenger feels forced in a direction opposite to that of the acceleration. If the automobile accelerates forward, the passenger is forced back into his seat. If the automobile accelerates backward (by braking, for example) the passenger feels forced forward. If the automobile accelerates toward the right, by rounding a curve toward the right, the passenger feels forced toward the left. If the automobile is not accelerating (for example when it is standing still or following a straight road at constant speed), the passenger feels no horizontal force.

The common contact of a switch can be considered a “passenger” in the switch. When the switch is accelerating in any direction, the common contact experiences an apparent force in the opposite direction. This may act to keep closed contacts closed, and open contacts open, in which case there is no problem. The force may be directed perpendicular to the line of movement of the common contact, and have no significant effect. However, if the force acts to separate closed contacts or to close open contacts, there is a possibility that the switch may have a malfunction. During the launching of a high velocity rocket, switches on the rocket are subjected to high linear acceleration. Switches used in the hub of a propeller, or in a spinning projectile, have a component of acceleration toward the center of rotation. The movable contact, as a passenger in the switch, may be forced in an unfavorable direction.

Up to this point, we have considered acceleration that is fairly uniform. In practice, acceleration often is of a transient nature. When a device containing a switch is struck, dropped, or otherwise subjected to a jar, it undergoes a pulse of acceleration known as a shock. In its simplest form, this transient acceleration is all in one direction, but its magnitude varies with time. A graph of the acceleration versus time may be a simple half-sine wave, or it may have any of a wide variety of shapes and dimensions. Although ordinarily mechanical shock has little or no effect upon switch performance, a shock pulse having high acceleration and relatively long duration, can cause a closed switch to open momentarily, or an open switch to close momentarily. If acceleration is very high, in the thousands of gravity units, some switches may be permanently damaged from the shock.

To judge the effect of most mechanical shocks on switches, remember the automobile analogy. If a standing automobile is struck from the rear, the blow accelerates it forward. The passenger feels forced in the direction opposite to that of the acceleration, and is forced back in his seat. If the standing automobile is struck from the front, or if a forward-moving automobile collides with an obstacle, it is accelerated toward the rear. The passenger feels forced in the opposite direction (forward). The common contact of a switch experiences similar forces when the switch is subjected to a mechanical shock, and the effect can be judged by considering the position of the contacts and the direction of the shock.

If a shock pulse has a fairly simple waveform (such as half-sine), it is usually specified in terms of acceleration versus time. If the shock wave is complex and cannot readily be expressed in this way, it is sometimes specified in terms of what it would do to a graduated series of tuned reeds, each representing a frequency, attached to a common base.

When this is done, the shock often is specified in terms of acceleration versus frequency, and the resulting graph is called a shock spectrum. If the duration of the shock pulse is of the same order of magnitude as the half natural period of some part of the switch mechanism, its effects on the switch may be amplified or attenuated. Thus, a shock pulse having a 50G peak acceleration may separate the closed contacts of a switch, while a steady acceleration of 50G in the same direction would not.

Vibration is an oscillating movement which may have a consistent, repetitive pattern or may be irregular. Thus the acceleration may vary regularly or irregularly. Most laboratory vibration tests provide simple harmonic motion, which is a sine wave. The acceleration then follows a negative sine wave, and is specified in terms of frequency and maximum acceleration. In applications where the vibration does not follow a simple waveform, conditions may be more difficult to specify. In some instances, the vibration is not periodic and the acceleration varies erratically. In the case of random vibration, a sampling of motion during a time interval shows that the instantaneous acceleration values are distributed in accordance with the Gaussian curve. Such vibration usually is specified in terms of spectral density (G^2/cps) versus frequency, and can be represented graphically on a log-log grid.

In vibration, as with the other forms of acceleration, the common contact can again be viewed as a passenger in the switch, and experiences an apparent force in the direction opposite to that of acceleration. With vibration, the acceleration is along an axis, first in one direction, then in the opposite direction. The magnitude and direction of acceleration are reversed rapidly, and the rate of change affects the response of the switch to the vibration. The closed contacts of a vibrating switch may remain closed at 10G, 50cps, but may separate momentarily at 10G, 500cps.

In summary, acceleration is any change of the velocity's magnitude or direction. Shock and vibration are forms of acceleration in which acceleration varies with time. The common contact, as a passenger (in the switch), behaves as though it were forced in the opposite direction of the acceleration. With this in mind, one can judge whether a given acceleration, shock, or vibration will act to cause closed contacts to open, or open contacts to close. If it appears that there may be a problem of this kind, several steps can be taken to prevent it:

1. Use a miniature switch. The mass of its moving parts is a major factor in the response of a switch to acceleration, vibration, or shock. Use of a subminiature switch is one of the most effective and least expensive remedies.
2. Orient the switch so the acceleration, shock, or vibration will not separate closed contacts or close open contacts. It may even be possible to orient the switch so the acceleration helps to hold the contacts in the desired position.
3. Keep the switch plunger fully released or fully depressed during acceleration, shock, or vibration to take advantage of the high contact force available at the extremes of plunger travel.
4. Be certain that the actuating device and switch mounting do not respond to acceleration, shock, or vibration, in such a way as to cause movement of the switch plunger.
5. Where shock or vibration is a problem, install the switch and actuating device on a shock mounted panel to attenuate the shock or vibration reaching the switch. Nothing is gained by shock mounting the switch or actuating device separately, since this permits relative motion of the two and causes undesired movement of the switch plunger.

6. Use two or more switches oriented differently from each other. For example, use two switches with their plungers pointed in opposite directions but actuated by a common linkage. An acceleration shock or vibration tending to separate the closed contacts of one switch will tend to hold the contacts of the other switch closed. If the intent is to keep the circuit closed, connect the closed circuits of the two switches in parallel. If the intent is to keep the circuit open, connect the open circuits of the switches in series. See **Figure 21**.
7. Make the electrical circuits less sensitive to momentary disturbance of the switch contacts. For example, if a switch is controlling a DC relay coil, a capacitor connected across the coil can increase the response time of the relay.
8. Test the switch in end use conditions. Laboratory acceleration tests performed with a centrifuge are quite valid if an application involves uniform unidirectional acceleration. Laboratory vibration tests are considerably less valid because it is difficult to duplicate conditions of end use accurately in the laboratory. Laboratory vibration tests are worthwhile if the results are applied with judgment. Incidentally, it is impossible to make a useful estimate of switch performance in random vibration, based on results of a sinusoidal test. Laboratory shock tests are used to demonstrate that switches conform to the shock requirements of applicable specifications. Beyond this, most laboratory shock tests have little practical use. With rare exceptions, every shock pulse encountered in the field is unique. Consequently, switches that pass a 50G shock test in the laboratory may experience contact chatter in a 20G shock end use. Similarly, switches with contact chatter during a 50G shock test may exhibit no chatter at 100G in the field. No laboratory test can determine the general shock resistance of a switch, or even rank switches for general resistance to shock. If shock resistance is important, test in end use equipment. Otherwise, close the door gently.
9. Specify performance requirements that reflect actual needs. One of the best ways to save time and money is to put into the performance specification only those requirements that are needed for the switch to perform properly in end use. Acceleration, shock, and vibration specifications are no exception. If a switch is required to hold a large solenoid energized during shock, and if a circuit opening of 1 millisecond would cause no problem, nothing is gained by requiring that contact separation time during shock not exceed 1 microsecond. Unnecessarily stringent specifications result in higher cost with no corresponding benefit in end use.
10. If a problem arises, consult the switch manufacturer. The ability of a switch to resist the effects of acceleration, shock, and vibration is determined by such factors as the magnitude and direction of spring forces, the distribution of mass in the switch mechanism, and the elastic properties and physical strength of the various parts of the switch. These characteristics of switch design are under the control of the switch manufacturer.

Figure 21: Use of redundant switches, actuated by common linkage, to prevent circuit disturbance by acceleration, shock, or vibration

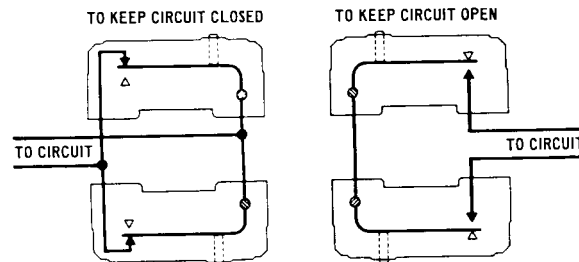

B. Acoustic excitation

Some electronic components are adversely affected by environments in which high intensity sound is present. The intensity of sound usually is expressed in terms of decibels. Any ratio can be expressed as a certain number of decibels. The decibel is simply ten times the common logarithm of the ratio. In acoustics, a value of 10^{-16} watts/cm² is assigned to the denominator of the ratio, so each value of the numerator corresponds to a specific number of decibels. Heavy artillery fire has a sound level of about 120 decibels.

From time to time, some concern is raised about the effect of acoustic excitation on switch performance. Even in the extremely high sound levels of heavy rocket launching, no switch problem from this cause has been reported. One would expect that the switches affected most by high-intensity sound would be those with diaphragm sealed plungers in which the diaphragm might respond to the sound and might even rupture. In switches, the small area of the diaphragm, together with its firm support and associated damping, prevent any significant response to high energy sound waves. A few instances have been reported in which a switch seemed to be responding to high energy sound, but the problem has invariably been traced to vibration of the mounting panel which was responding to the sound. When the mounting panel was reinforced, it dampened or stopped vibrations from being transmitting to the switch, and the problem disappeared.

C. Corrosion

Unless it is specifically designed for the purpose, an unsealed switch in a corrosive environment is likely to have a short life. The internal mechanism of a snap-acting switch is designed to meet a combination of electrical and mechanical requirements at normal operating conditions, and this usually involves some highly-stressed parts. A corrosive environment may lead to the combinations of stress and corrosion that bring early fracture. In addition, corrosive products may fall on the switch contacts, causing resistance problems, or they may deposit on an insulator, causing a short circuit. Unsealed switches can be built from materials selected to reduce galvanic effects. Many switches designed for use at high temperature make use of alloys which happen to be inherently resistant to corrosion.

If a corrosion problem is confined to one area in an unsealed switch, such as the most highly stressed part of a leaf spring, it may be possible to protect the affected area with an organic coating so the corrosive medium cannot reach it. The simplest solution is to use a sealed switch chosen to withstand the corrosive environment in question.

D. Explosion

Explosive mixtures of gas, vapor, or dust with air can be detonated by an electric arc, if the energy of the arc is at least as high as the ignition energy of the mixture. In general, gases produce the most violent explosions, with vapors ranking next, and dusts the least violent. Obviously, an unsealed basic switch is unsuitable for use in explosive environments. The use of switches and other electrical equipment in explosive atmospheres is closely governed by electrical standards which set minimum construction requirements, installation procedures, classifications of explosive atmospheres and test criteria that must be met for approval. Among the control bodies having standards of this kind are National Electrical Code, Underwriters Laboratories, Canadian Standards Association, U. S. Bureau of Mines, Department of Defense, and National Fire Protection Association. Each of these organizations is concerned with preventing explosions, which in the case of flammable gas or vapor may be ignited by arcing contacts. Combustible dusts may be ignited by heating.

In designing switches for explosive environments, the chief considerations are the tendency of the mixture to explode, explosion pressure of the mixture when detonated, ability of the switch enclosure to withstand an external explosion without damage, and flame arresting capabilities of the switch enclosure in the event of an internal explosion. Switches designed for use in explosive environments must be able to withstand an internal explosion without igniting the explosive mixture surrounding the switch enclosure. The enclosure is thus designed to withstand the maximum expected internal explosion pressures without damage or excessive distortion, and to provide venting for the pressure through channels of such dimensions that gases will be cooled below the ignition temperature before reaching the surrounding atmosphere. Thus the design of an explosion proof switch enclosure involves careful consideration of thickness of housing, fit of cover and fit of shaft joints.

The minimum ignition energy of an explosive atmosphere is affected by ambient temperature and humidity, as well as by pressure and other factors. If arc energy exceeds this ignition energy, increasing the electrical load has no effect on the tendency to detonate or on the resulting explosion pressure. Obviously, a switch that has passed a particular explosion test is not necessarily safe for use in all explosive or flammable environments. As always, it is best to test under the conditions expected in end use. When selecting an explosion proof switch, choose one with adequate mechanical life, as the fit of the actuator seal is critical and important, and must be maintained throughout the useful life of the switch.

E. Fungus

Fungi grow fastest in warm, damp and dark environments in the presence of certain organic salts. Fungus growths on or in a switch constitute contamination. On switch contacts in low energy circuits, fungi may cause high resistance. On insulators, they may set up a low resistance path resulting in excessive leakage current to ground. Aside from such passive roles, fungi may attack switches actively. They can cause oxidation, reduction, or hydrolysis of organic materials. They may attack plastics containing cellulose fillers, such as linen, cotton, or wood flour. They also may attack elastomers containing catalysts, plasticizers, or fillers that are fungus-susceptible. Such problems can be prevented by using sealed switches that have all exposed surfaces made from nutrient free or fungicidal materials.

F. Humidity

Standard unsealed switches will perform satisfactorily in most environments, including those having high humidity. However, prolonged exposure to high humidity, or to rapid changes of temperature and humidity can degrade switch performance. Humidity has both direct and indirect effects upon switch performance. It acts directly on plastics to cause dimensional changes, reduce physical strength, and degrade electrical properties. It can also reduce fatigue life of springs. Humidity acts indirectly by combining with other environmental conditions to affect switch performance. For example, humidity makes it possible for sulfides in the air to tarnish silver contacts, occasionally causing problems on low energy circuits. An electric arc, in the presence of humidity, produces nitric acid and corrosive oxides of nitrogen, which can attack metallic parts of the switch mechanism. In applications involving fluctuating temperature, humidity may condense and even freeze on an unsealed switch. Carrier-based aircraft are exposed to this condition, in addition to the rapid increase of atmospheric pressure during a dive, which can force condensate into unsealed switches.

Minor effects of humidity, such as changes in switch operating characteristics, usually can be remedied by changes of plastics. The switch contact corrosion problems that sometimes occur when moist air and severe arcing from DC inductive circuits are combined, usually can be reduced or eliminated. This can be accomplished by adding an arc suppression circuit, such as, a diode connected in the blocking mode across the coil. The more serious problems that may result from prolonged exposure to high humidity, or rapidly cycling humidity, are best avoided by use of sealed switches.

G. Ice

Ice formation can be a problem when it interferes with the normal actuation or release of switches. An ice coating can withstand considerable force, its strength depending upon the conditions under which it is formed. Sealed switches are a necessity where ice formation is likely to occur. Unsealed switches may experience frosting at the contacts as well as external interference with actuation. The material, geometry, and finish of the external parts of a switch determine to some extent how tightly an ice coating will cling. The force of the plunger return spring is the most important factor in assuring that the switch will release, despite an ice coating.

Research indicates that the only surface to which ice cannot adhere is one coated with a liquid or semisolid lubricant which retains its lubricating properties at low temperature. Some enclosed switches are designed with the plunger terminating in a clevis, connected to the actuating device with a pin. This allows the switch plunger to be driven positively in both the actuating and release directions and makes it unnecessary to rely upon the internal force of the switch to break the ice.

Laboratory ice tests rate “poor” in validity and reproducibility. In switch applications, it is found that ice almost never deposits as a uniform coating. Rather, it often tends to build up as a pile or prismatic ridge on one side of the switch, leaving the opposite side virtually bare. The quality, and hence the strength of the ice, varies widely. Ice formed on switches in the slipstream of flying aircraft has properties that differ from those of the ice buildup that was due to freezing of condensed moisture in still air. Similarly, in the laboratory, ice applied to a switch using water from a spray gun is different than ice formed by alternate immersion and freezing. The most nearly reproducible (but not necessarily valid) ice tests are those performed by alternately immersing the switch in ice water and freezing it in a low temperature chamber. By controlling temperature, time, sample orientation, and the number of immersion-freezing cycles, one achieves the closest possible approach to a reproducible test. It is pointless to specify an ice test in terms of ice thickness. Ice is thin at the outside corners and tends to form fillets at the inside corners. Furthermore, ice thickness can only be measured accurately by breaking the coating, thus destroying the test. In short, actual trial of the switch in its end use environment is much more useful than a laboratory ice test.

H. Liquid

Unsealed switches sometimes are accidentally splashed when adjacent parts of equipment are being oiled, or filled with hydraulic fluid, or fuel. The effects can be devastating. The exposure of unsealed snap-acting switches to liquid splash or immersion, whether accidentally or by design, is an extremely hazardous practice. Depending upon several factors, it can cause the switch circuit to fail (open or closed), start a fire, or cause an explosion. Because of the importance of taking precautions in this area, and because users sometimes feel that such precautions can be ignored “just this once,” the following information on how liquids affect unsealed switches is provided.

Consider what happens when a standard unsealed switch is splashed with petroleum oil. The oil soaks into the switch case, dissolving the plastic to some extent. First the pigment dissolves, soon followed by some of the partially polymerized plastic. The effect is to erode the material and reduce its dielectric strength by releasing polar organic compounds into the solvent oil. Although phenol formaldehyde plastics resist oxidation, some of the compounds found in petroleum oils can oxidize the material when heated. Among these compounds are cresols, nitrates, and organic sulfates. The reaction produces compounds which are electrolytes and, hence, conductive. This provides a path for electric current to bypass the open switch. When the oil reaches the contacts of the switch, the electrical load determines what happens next. If the load is such that there is no arc at the contacts, the oil (and any debris carried by it into the switch) can deposit between the contacts and the switch may fail to close the circuit. If these deposits do not close the circuit, the resistance of the contamination between the contacts may be so high that the component being controlled by the switch will not have enough voltage for reliable operation.

If the electrical load is high enough to cause an arc at the switch contacts, the electric arc burns some of the oil, forming water, CO₂ and carbon. The water contaminates the remaining oil and the phenolic case material, reducing the insulating properties of both. Carbon deposited on the surface of the phenolic provides a low resistance path for electric current. At the same time, a carbon residue remains on the contact surfaces, increasing the energy of the arc itself. (This assumes that the carbon clinker has not prevented the contacts from closing the circuit). The upshot is that the insulating material begins to lose its insulating ability and leaks current, often to the grounded surface on which the switch is mounted. As leakage current increases, I²R heating hastens combustion of the oil and degradation of the case material. This, in turn, reduces the resistance of the current leakage path and increases the leakage current. In other words, the condition is self-aggravating and a conductive path is burned through the case of the switch. In its final stages, dielectric breakdown can be quite a spectacular, with showers of sparks, tongues of flame and a spray of molten metal. It is even more spectacular if it occurs in a flammable or explosive environment.

What if an unsealed switch is immersed rather than splashed? The liquid may attack the plastics as described above. If the liquid is flammable, and if the switch is kept completely immersed so that oxygen cannot reach it, dielectric breakdown of the switch is not likely to ignite the liquid, unless hot metal ejected from the switch reaches the surface of the liquid while still above the ignition temperature of the vapor. Of course, if the liquid is a chemically unstable mixture that can burn without additional oxygen, dielectric breakdown of the switch may ignite it directly. A definite hazard exists if the switch is only partially immersed or is immersed only part of the time, as it might be in a fuel tank. This then reverts to a flammable vapor which can be ignited by the arc or dielectric breakdown of the switch.

What if the liquid is not flammable - water, for example? This sometimes happens when moisture condenses in a wiring conduit and runs into the attached switch enclosure. The moisture distorts the plastic parts of the switch and may change the operating characteristics. As the switch stands open, partially immersed in contaminated water and connected to the power line, leakage current passes through the water. This, in itself, is a hazard because the circuit is not completely open. Inside the switch, electrolysis begins to destroy the mechanism and eventually the switch fails completely.

The lesson is clear - do not contaminate unsealed switches with oil or other liquids, either by splash or immersion. Use sealed switches where such contamination is possible, and avoid the hazards mentioned.

I. High Pressure

Unsealed switches designed primarily for use at sea level will perform satisfactorily in air at high pressure, with no reduction of electrical rating. However, many high pressure switch applications involve media other than air, such as sea water. In many of these instances, a sealed switch must be used. The case of a sealed switch will experience higher external than internal pressure, and the effects of the resulting pressure differential must be considered. If the switch has a plunger-type actuator, the ambient pressure will act upon it as a piston and provide a residual force (pressure times cross-sectional area of the plunger) tending to depress the plunger. At moderate pressures, this will appear only as a reduction of operating and release forces.

If ambient pressure is high enough, however, it can cause spontaneous actuation or failure of the actuated plunger to release. At extreme high pressure, the switch case may suffer temporary distortion or permanent damage. Maximum allowable pressure figures are available from manufacturers of sealed switches, and special switches are available for use at very high ambient pressures.

NEMA Standard Enclosure Types

Type	Name	Description and Use
1	General Purpose	Protects against dust and light, indirect splashing, not dust-tight; primarily prevents contact with live parts; used indoors and under normal atmospheric conditions.
2	Drip Tight	Similar to Type 1 with addition of drip shields or equivalent; used where condensation may be severe, as in cooling rooms and laundries.
3	Weather Resistant (Rain Tight)	Protects against weather hazards such as rain and sleet; used outdoors on ship docks, for construction work, in tunnels and subways.
4	Water Tight	Must exclude at least 65 gpm of water from a 1 inch nozzle delivered from a distance not less than 10 ft. for 5 minutes. Used outdoors on ship docks, in dairies, and breweries.
5	Dust Tight	Provided with gaskets or equivalent to exclude dust; used in steel mills and cement plants.
6	Submersible	Design depends on specified conditions of pressure and time; used for submersion in water, as in quarries, mines, and manholes.
7	Hazardous Location Class I (Explosive Gas or Vapor)	Meets application requirements of National Electrical Code; conforms with specifications of Underwriters Laboratories Inc., used for atmospheres containing gasoline, hexane, naphtha, benzene, butane, propane, acetone, benzol, lacquer-solvent vapors, and natural gas.
8	Not applicable to snap-acting switches.	
9	Hazardous Locations Class II (Combustible dust)	Meets application requirements of National Electrical Code; conforms with specifications of Underwriters Laboratories Inc., used for atmospheres containing metal dusts, carbon black, coal or coke dust, flour, starch, or grain dusts.

J. Low Pressure (vacuum)

A snap-acting switch designed primarily for use at room conditions will give satisfactory performance at reduced atmospheric pressure, within the limits of the switch’s electrical ratings for that pressure. Often the electrical ratings at reduced pressure are lower than those at sea level atmospheric conditions. If this reduction of ratings cannot be tolerated, remedies are available and will be discussed later in this chapter. Since switch applications in a vacuum usually involve aircraft or spacecraft, atmospheric pressures will be expressed in terms of the corresponding altitudes. It is wise to remember that a switch intended for use at X thousand feet may also have to operate at altitudes up to X thousand feet.

As an unsealed switch is exposed to increasing altitudes, its dielectric strength and its ability to interrupt current first decrease, then increase until they exceed the capability at sea level. At the extreme altitudes of outer space where a hard vacuum prevails, contacts or other metallic bearing surfaces may cold-weld, and sublimation of materials may present problems. The dielectric strength and current interrupting ability of an unsealed switch vary continuously with altitude, but not all switches behave alike. The altitudes mentioned in the following discussion are the

approximate levels or ranges at which the practical performance of most unsealed snap-acting switches is affected.

Effects of Vacuum on Unsealed Switches

Absolute Pressure (torr)	Approximate Altitude (feet)	Switch Phenomena Caused by Reduced Pressure
1.4×10^{-8} and below	1 1/2 million and above	Seizing and galling of metal surfaces in contact. Possible cold welding.
3.5×10^{-6} and below	500,000 and above	Aggravated electrical welding of contacts.
8.5×10^{-5} and below	350,000 and above	Enhanced current interrupting ability, but voltage transients may damage insulators. Dielectric strength of air so high that any breakdown is likely to be over surface or through body of an insulator. Evaporation and sublimation of materials becomes significant and increases with altitude.
8.92×10^{-3}	260,000	Dielectric strength and current interrupting ability about equal to sea level values. Both increase above this altitude.
2.27 to 1.3×10^{-1}	130,000 to 90,000	Dielectric strength and current interrupting ability lowest at some point in this range.
3.366×10^{-1}	70,000	Dielectric problems in unsealed switches on AC loads above this altitude.
2.824×10^{-2}	25,000	Significant decrease of dielectric strength and current interrupting ability above this altitude, up to about 260,000 feet.
7.60×10^{-2}	0	Basic performance figures established here.

* U.S. Standard Atmosphere, 1962.

Reduction of Dielectric Strength

A vacuum can reduce the voltage an open switch will tolerate without breakdown. An unsealed switch at sea level may withstand a potential of 1500 volts impressed across the open contacts, without breakdown. Yet the same switch at 65,000 feet may break down at 500 volts. Although the dielectric strength of air decreases gradually with increasing altitude, no switch problems have been reported from this cause below 25,000 feet. Above 25,000 feet, the reduction of dielectric strength is significant, it reaches a minimum at some point between 90,000 and 130,000 feet. Above this point it increases with altitude. At about 260,000 feet, dielectric strength again reaches its sea level value. At 350,000 feet, dielectric strength of air is so high that any breakdown of the switch is likely to be over the surface or through the insulating material rather than between the open contacts, regardless of their spacing. In the range from about 60,000 feet to about 260,000 feet, breakdown may take the form of a momentary flash-over or a partial breakdown in the form of a corona discharge. Either of these may (or may not) be followed by a total breakdown, destroying the switch. Unsealed switches are seldom used to control AC circuits in this range, because of the relatively high voltages involved.

Reduction of Current Interrupting Ability

A partial vacuum can increase the energy of the electric arc and thus reduce the current interrupting ability of an unsealed switch. There is no significant change between sea level and 25,000 feet.

For safety, it should be assumed that arcing at the contacts of unsealed switches becomes increasingly severe as altitude is increased above 25,000 feet, and reaches maximum severity at some point between 90,000 and 130,000 feet. As altitude is increased beyond this point, arcing becomes less severe until, at about 260,000 feet, it is approximately the same as at sea level. At still higher altitudes, the arc becomes less severe. Above 350,000 feet, arc time becomes very short and current interrupting ability of an unsealed switch is greatly enhanced. The extremely short arc time above 350,000 feet means a very high rate of change of current with respect to time, resulting in high voltage transients. This, in turn, can cause dielectric breakdown of insulation elsewhere in the circuit.

Increased Tendency of Contacts to Weld

A very high vacuum can aggravate contact welding. In the virtual absence of air, convection currents do not exist and heat is drawn away from the contacts of unsealed switches only by radiation or metallic conduction. At the same time, the vacuum helps to clean and de-gas the contact surfaces, making conditions more favorable for contact welding. Significant welding may occur above 500,000 feet, with heavy electrical loads, and at 1½ million feet, contacts may weld without an electrical load. This same cold-welding phenomenon can cause binding, seizing, galling, and accelerated wear of the metal bearing surfaces exposed to the vacuum.

Evaporation and Sublimation of Materials

As the prevailing pressure approaches the vapor pressure of the materials in an unsealed switch, the rate of evaporation and sublimation may become appreciable. The resulting vapors can leave deposits on surfaces of adjacent parts, forming conductive films on insulators and insulating films on contacts. Lubricants may be especially prone to evaporation in a vacuum unless they are designed for that environment.

Switches designed for use at reduced atmospheric pressures often have the contacts in a sealed, gas filled chamber that maintains the gas around the contacts at sea level pressure, regardless of the ambient vacuum. In some cases, the switch terminals are exposed, while in others they are brought out of the switch as potted leads. The type of actuator seal used depends upon the intended use of the switch. If the switch is to be exposed to a vacuum intermittently with appreciable recovery time between exposures, as in aircraft, the switch plunger can be sealed with an elastomer diaphragm or an “O” ring. If the switch is to be exposed continuously to high vacuum for a matter of weeks or months, as in some space vehicles, elastomer sealed switches will lose their fill gas gradually by diffusion. During any such leakage, the gas pressure in the switch will pass through pressures corresponding to all of the altitudes below the one to which the switch is exposed, and the switch may experience any or all of the problems associated with an unsealed switch at each altitude. Switches intended for continuous use in a vacuum usually are hermetically sealed, with metal-to-metal and glass-to-metal joints.

When choosing a sealed switch, be sure to select one having the necessary mechanical life to assure that the seal will remain intact. Breakage of the seal results in gross leakage. If a switch with a gross leak is exposed to a vacuum, the gas in the switch leaks into the vacuum until the pressure inside the switch equals that outside the switch. If the gross leak is a minor one, this process may take an hour or more to occur. If a switch on an aircraft landing gear develops gross leakage, it will lose its internal pressure during flight. Then during landing, air will flow into the switch through the leak, perhaps carrying with it water and dirt splashed from the runway.

K. Nuclear radiation

Precision switches are used as limit switches to sense the position of the control rods of nuclear reactors. They have numerous other applications in nuclear power generating plants and particle accelerators, where the levels of neutron or gamma radiation are high. Nuclear radiation can reduce the electrical performance of a switch by ionizing the gas between the contacts, and by causing permanent damage to organic materials in the switch. Most material damage due to nuclear radiation occurs in one of three ways:

1. Elastic collision of radiation particles with atoms of the material, displacing the latter in the crystal lattice.
2. Transmutation when an atom of the material captures a neutron and gains mass.
3. Ionization caused by recoil atoms traversing the lattice, or by beta rays, X-rays or gamma rays.

Most precision switches are not damaged by gamma radiation exposures below 10^7 roentgens. Above that level, the effect depends largely upon the materials of the switch. The overall effect is approximately the same as that of exposing the switch to high temperature. Flexible rubber or elastomer parts and lubricants stiffen, and plastics gradually become brittle. At the same time, the insulation resistance and dielectric withstanding voltage decline. On the basis of tests of a variety of switches in gamma radiation, the permanent effects of both gamma and neutron radiation on a given switch design can be estimated with reasonable accuracy.

The exact effect of ionizing radiation on electrical performance of a switch can be determined only by testing. A test is recommended if the switch is to control a circuit at or near its rated current, or if an especially long life is required, or if failure of the switch would have dire consequences. Ionizing radiation increases arc time, since the gas between the separating contacts requires longer to deionize. This is likely to reduce the life of the switch to some extent. However, if the switch is not required to close or open the circuit while exposed to radiation, only the permanent effects of radiation on the structure of the switch need be considered.

If radiation levels are high enough to affect performance of the switch, special materials may be employed. For example, in some instances, ceramics can be used instead of plastics. Another measure is to shield the switch from the radiation, either by a separate barrier or by using a metal enclosed switch of suitable design. A third possibility is to install the switch at a location remote from the area of intense radiation, transmitting motion to the switch plunger by a mechanical linkage.

The switch manufacturer can provide assistance in calculating radiation dosage, estimating effects of radiation and recommending appropriate switches for specific applications.

L. Sand or dust

Practical problems with switch resistance are rare, but those that do occur usually can be traced to particles of foreign matter on the contacts. An unsealed switch in an environment containing a high concentration of sand or dust is almost certain to have resistance problems and is likely to fail to close its circuit at all. If the particles are abrasive, they may, in addition to contaminating the contacts, reduce the life of bearing surfaces and even cause mechanical jamming of the switch mechanism.

Such particles can cause leakage of sliding seals that are not designed to resist their effects. A sealed switch of suitable design is a necessity for reliable operation in sand and dust environments. When selecting a switch for this purpose, be sure to choose one having an adequate mechanical life rating, so that the seal will remain intact.

M. High temperature

Snap-acting switches designed for use at room temperature will perform reasonably well at temperatures up to about 180°F (82°C). Above the maximum temperature for which a switch is rated, however, several effects may act to cause trouble. Some of these, such as differential expansion of parts, the increase of gas pressure in sealed switches, and the reduction in modulus of elasticity of the spring material, take place immediately, while others are time dependent. Among the latter are the drying of lubricants and elastomer seals, the deterioration of plastics (cracking, brittleness and decreased ability to withstand moisture penetration), and the accelerated degradation of contacts under electrical loading. These can cause changes of plunger travel and force characteristics, binding of bearings, leakage of originally sealed switches, excessive leakage current through the open switch or from terminals to the grounded mounting surface, and reduction of switch life.

As a rule, if a switch is used above its rated temperature, the higher the temperature and the longer the exposure, the poorer the performance of the switch will be. A single, short-duration temperature overshoot with the switch not operating may have no significant effect on switch performance. A longer exposure to a less extreme temperature overshoot, with the switch operating, may render the switch unfit for further use. In practice, high temperature frequently occurs as part of a cyclic temperature condition to which the switch is exposed, as in the plenum control of a household furnace. The alternate expansion and contraction of air in the switch as a result of the cycling temperature can cause the switch to “breathe.” This presents no problem unless the breathing draws contaminants into the switch.

The upper temperature limit of a switch can be raised by incorporating special materials and dimensions to reduce or avoid the problems mentioned above. Switches designed for use at high temperatures are also satisfactory for room temperature service, but they should not be used at low temperatures without consulting the manufacturer.

For best switch performance at high temperature, observe the following precautions: If possible, actuate the switch in line with the axis of its plunger. If side thrust cannot be avoided, as in cam actuation, choose a switch designed for the purpose. Do not apply excessive force to the plunger (information on maximum allowable force is available from the manufacturer). Avoid high current at high temperature, if possible, to reduce the I²R heat supplied by the switch itself.

N. Low Temperature

Many switches designed for use at room temperature perform well at temperatures approaching absolute zero, but others are unsuited for use below -30°F (-34°C). Switches should not be used at low temperature without considering how they may be affected. Below the minimum temperature for which a switch is rated, lubricants may congeal, elastomer seals may stiffen and break, plastics may become brittle, springs stiffen and, at cryogenic temperatures, some metals shatter readily.

Differential contraction can cause bearings to bind and sealed switches to leak. The result is that operating characteristics may change and the switch may be temporarily disabled or permanently damaged. If the plunger of a switch is sealed by an elastomer diaphragm or an “O” ring, or if liquid or grease lubricants are employed, the return of the plunger from its actuated position may be delayed or even prevented by low temperature. Furthermore, a simple cold test may not show what will happen with long-term exposure to low temperature. For example, grease may congeal gradually over a period of days or weeks. Switches that are to be held in the actuated position at low temperature for long periods of time should be evaluated with this in mind.

Switches designed for low temperature service perform satisfactorily at room temperature. The low temperature feature is obtained by special materials and dimensions. Low temperature switches should not be used at high temperature without consulting the manufacturer.

For best switch performance at low temperature, actuate the switch in line with the axis of its plunger. If side thrust cannot be avoided, as in cam actuation, choose a switch designed for side-thrust actuation. If possible, avoid holding the switch plunger in the actuated position at low temperature for long periods of time, especially if the plunger is required to return rapidly when released. A clevis linkage, such as the one described for use in ice environments, may be useful to assure rapid return of the switch plunger at low temperature.

If a sealed switch containing dry nitrogen at atmospheric pressure and room temperature is cooled to a temperature approaching absolute zero, will the nitrogen liquefy and then freeze? For liquefaction and solidification to occur, three conditions must exist: (1) the gas must be at or below the critical temperature, (2) at or above the critical pressure, and (3) must exceed the critical volume. A sealed switch usually can be considered a constant volume system. As temperature is reduced, the gas pressure decreases but the density remains constant. The reduction of pressure is caused by reduced molecular velocity. We will leave it as an exercise for the reader to decide whether or not the gas remains gaseous. Meanwhile, just in case of a misplaced decimal point, it is best to test the switch before relying upon it at cryogenic temperatures.

O. Temperature shock

Most switches are not damaged by sudden transitions from one temperature to another as encountered in practice. An occasional problem may arise from an accidental splash of a warm switch with liquid nitrogen or other cryogenic fluids, but damage from such causes is rare. The damaging effect of thermal shock is differential expansion or contraction between parts, or even within one part, when temperature changes rapidly. When damage does occur, it takes the form of slight cracking of plastics or separation of bonded joints, causing originally sealed switches to leak. Rapid fluctuation of temperature causes unsealed switches to “breathe” as the air within them expands and contracts. If moisture is present on the outside of the switch, it may be drawn into the switch case as the switch is cooled. This may occur, for example, in the steam cleaning of switches on food processing machinery if the cover of a switch enclosure is not properly tightened. As the enclosure cools following steam cleaning, moisture condenses and is drawn into the enclosure past the loosely fitting cover.

Conclusion

If actual environments had only one significant component, such as temperature or pressure, switch application in hostile environments would be relatively easy. But, in practice, the numerous components of the environment combine in many ways to influence the kind and rate of electrical and mechanical deterioration of the switch. For help in choosing the right switch and applying it correctly, consult the switch manufacturer.

Glossary of Switch Terms

Acceleration - The rate of change of velocity. Acceleration has two characteristics: magnitude and direction.

Actuation - Operating or releasing a switch by depressing or releasing its plunger or rotating its shaft.

Actuator - The mechanical link that drives the plunger of a basic switch or the shaft of a rotary switch.

Air Gap - See Break Distance.

Ambient - Surrounding.

Anode - The switch contact connected to the positive terminal of the power supply.

Arc - One of several kinds of visible electrical discharge between separated contacts of a switch. It is primarily a stream of electrons and is accompanied by incandescent metal vapor.

Auxiliary Actuator - A mechanism which may be attached to a switch to modify its operating characteristics.

Basic Switch - A complete and self-contained switching unit of which there are many shapes and sizes. Basic switches may be used alone, gang-mounted, built into assemblies or enclosed in metal housings.

Bifurcated Contact - A movable or stationary contact which is forked or divided to provide two pairs of mating contact surfaces connected in parallel, instead of a single pair of mating surfaces.

Break - An interruption in a circuit is known as a break. Break denotes the number of pairs of separated contacts the switch introduces into each circuit it opens. If actuating the switch opens the circuit in one place, then the switch is a single break switch. If actuating the switch opens the circuit in two places, then the switch is a double break switch.

Break Distance - The minimum distance between separated mating contacts in their fully open position.

Catalyst - A substance which changes the rate of a chemical reaction but is itself not changed. Switch contact material sometimes acts as a catalyst, accelerating the formation of polymers on the contact surface.

Cathode - The switch contact connected to the negative terminal of the power supply.

Characteristics, Operating - See Operating Characteristics of a Switch.

Dead Break - Imperfect snap-action in which the normally closed circuit of the switch opens before the plunger reaches the operating point, or the normally open circuit opens before the plunger reaches the release point.

Dead Make - Imperfect snap-action in which a switch fails to close its circuit when the plunger reaches the operating or release point.

Dielectric - The term dielectric is almost synonymous with electrical insulation, which can be considered the applied form of the dielectric.

Dielectric Breakdown - Rupture of insulating material when the electric stress exceeds the dielectric strength of the material.

Dielectric Strength - The maximum potential gradient that a material can withstand without rupture. As a material property it usually is calculated by dividing the breakdown voltage by the thickness of the material between a pair of test electrodes. The term often is applied to switches to mean the maximum voltage a switch can withstand between specified terminals or between terminals and ground without leakage current exceeding a specified value.

Differential Travel - The distance from the operating point to the release point.

Drift of an Operating Characteristic - An inexact term referring in a general way to the degree of instability of a plunger force or travel characteristic under specified conditions and during a specified number of cycles of switch operation.

Dry Circuit - A slang expression meaning a low energy circuit. Although many individuals and groups have assigned current and voltage values to “dry circuits” there is at present no general agreement as to what the values should be.

Electrical Life - Life of a switch under a specified combination of electrical load, actuation, environment, and criterion of failure. Synonymous with switch life.

Enclosed Switch - One or more basic switches enclosed in a protective housing.

Erosion, Contact - A general loss of material from one or both working surfaces of a pair of mating contacts, as a result of switching an electrical load.

Force, Contact - The force holding closed contacts together.

Force Differential - The difference between the operating force and the release force.

Free Position of the Plunger - The position of the plunger when there is no external force other than gravity applied to it.

Full Overtravel Force - The force required to depress the plunger of a switch to the full overtravel point.

Full Overtravel Point - That position of the plunger beyond which further overtravel would cause damage to the switch or actuator.

Gravity Unit - One gravity unit (abbreviated g) is an acceleration of 32 feet per second².

Low Energy Circuit - A qualitative term having no exact definition. It usually refers to a circuit having such low voltage and current that there are no significant thermal effects at the contact interface.

Maintained Contact Switch - A switch which remains in a given condition until actuated to another condition, which also is maintained until further actuation.

Mechanical Life - Life of a switch with no (or a negligible) electrical load, and a specified combination of actuation, environment and criterion of failure. Mechanical life usually is limited by the life of the switch’s flexing parts and bearing surfaces.

Migration, Contact Material - A net transfer of material from one contact to the mating contact as a result of switching an electrical load. It usually takes the form of a needle, cone or mound on one contact face and a corresponding pit in the surface of the mating contact.

Minimum Life - This is an exact term only when applied to a specific group of tested switches. It then means the lowest life figure obtained from the test of that group of switches.

Momentary Contact Switch - A switch which returns from the operated condition to its normal circuit condition when the actuating force is removed.

Noncontact - A slang expression referring to a defective condition in which a supposedly closed switch lacks electrical continuity.

Normal Contact Position - The normal contact position of a switch exists when no force is applied to the plunger.

Normally Closed - The normally closed circuit of a switch is the electrically continuous path through the switch when the switch is in the normal contact position, i.e., when no force is applied to the plunger. In a typical switch it consists of the common wiring terminal, the normally closed wiring terminal and the electrically conductive path between them.

Normally Open - The normally open circuit of a switch is the electrically continuous path through the switch when the switch plunger is at the operating point or in the overtravel range. This path is open (nonconductive) when the switch is in the normal position, hence the term, normally open. In a typical switch it consists of the common wiring terminal, the normally open wiring terminal, and the electrically conductive path between them.

Operated Contact Position - The position to which the contacts move when the plunger is traveled to the operating point or into the overtravel range.

Operating Characteristics of a Switch - The commonly specified force, torque, and linear or angular travel properties of a switch. Examples are operating force, release force, operating point, differential travel and overtravel.

Operating Point - That position of the plunger at which the contacts snap from the normal contact position to the operated contact position.

Operating Force - The force which must be applied to the plunger to cause the moving contact to snap from the normal contact position to the operated contact position.

Overtravel - As an operating characteristic of a switch, overtravel is the distance through which the plunger moves when traveled from the operating point to the full overtravel point. As a characteristic of the actuation applied to the switch, overtravel is the distance the plunger is driven past the operating point.

Pole - The number of completely separate circuits that can pass through a switch at one time. A single pole switch can control only one circuit at a time. A double pole switch can control two independent circuits (such as a 120 volt AC heater and a 6 volt DC lamp) at the same time. The number of poles is completely independent of the number of throws and number of breaks.

Polymers Between Contacts - Compounds having long chain molecular structure, formed from simple organic contaminants on contacts, under the influence of contact wipe and the catalytic effect of the contact material.

Precision Snap-Acting Switch - National Electrical Manufacturer's Association defines a precision snap-acting switch as "a mechanically operated electric switch having predetermined and accurately controlled characteristics, and having contacts other than the blade and jaw, or mercury type, where the maximum separation between any butting contacts is 1/8 inch. A precision snap-acting switch consists of a basic switch used alone, a basic switch used with actuator(s), or a basic switch used with actuator(s) and an enclosure."

Pretravel - The distance through which the plunger moves when traveled from the free position to the operating point.

Release Force - The level to which force on the plunger must be reduced to allow the contacts to snap from the operated contact position to the normal contact position.

Release Point - That position of the plunger at which the contacts snap from the operated contact position to the normal contact position.

Release Travel - As an operating characteristic of a switch, release travel is the distance through which the plunger moves when traveled from the release point to the free position. As a characteristic of the actuation applied to the switch, release travel is the distance the plunger is released past the release point.

Repeatability of an Operating Characteristic - See the preferred term, Stability.

Shock, Mechanical - A short pulse of acceleration, usually lasting only a few milliseconds. A typical shock test pulse is a half-sine acceleration wave having 100G peak and .007 second duration.

Silica - Silicon- dioxide (SiO_2) is sand and the main constituent in glass. Silica is an electrical insulator.

Silicon - The element (Si). It most abundantly occurs in nature in combined form with oxygen (O) as silica (SiO_2).

Silicone - is a polysiloxane polymer where Si-O-Si form the backbone structure along with alkyl and aryl groups attached to the silicon atoms in the main chain. Silicones can degrade at high temperature and decompose into silica (SiO_2) and other compounds.

Snap-Action - In strict terms, snap-action is a property of a switch such that the moving contact accelerates without added travel of the plunger beyond that travel which was required to separate the contacts. National Electrical Manufacturer's Association defines snap-action as "a rapid motion of the contacts from one position to another position, or their return. This action is relatively independent of the rate of travel of the actuator." The word "relatively" is important. In actual fact, the acceleration of the moving contact is partially dependent upon the velocity of the plunger. The important point is that, once the plunger reaches the operating or release point, the movable contact immediately transfers to its opposite position without further travel of the plunger. A non-snap acting switch lacks this feature.

Stability of an Operating Characteristic - The extent to which an operating characteristic such as operating point remains constant during a specified number of cycles of switch operation, under specified conditions of actuation, electrical loading, and environment. It is most clearly expressed as a graph of the characteristic versus cycles of switch operation.

Sublimation - The change of state of a material from solid to vapor and back to solid without going through a liquid state.

Throw - The number of circuits that each individual pole of a switch can control. The number of throws is completely independent of the number of poles and number of breaks. A single-pole double-throw single-break switch connects the common terminal of the switch to the normally closed terminal when the plunger is free, but connects the common terminal to the normally open terminal when the plunger is depressed. A single-pole single-throw single-break switch has a common terminal and either a normally open terminal or a normally closed terminal but not both.

Total Travel - The distance from the plunger free position to the full overtravel point.

Transfer, Contact Material - See Migration.

Velocity - The rate at which the position of a moving object is changing. Velocity has two characteristics: magnitude (speed) and direction.

Welding, Contact - One of several conditions that may cause switch contacts to fail to separate at the intended point of plunger travel. As the name implies, the contacts literally are welded together as a result of the electrical and thermal effects at the contact interface.

Index

A

abrasive94
 AC inductive49
 acceleration10, 41, 54, 65, 73, 74,
75, 76, 78, 79, 100, 3, 6
 acoustic excitation.....79
 actuating device.....8, 10, 38, 42, 76, 77, 84
 adhesive.....35, 57
 alloys27, 30, 32, 80
 alternating current57
 altitudes88, 89, 91
 ambient temperature.....56, 68, 81
 anode44, 45
 arc4, 12, 25, 27, 30, 32, 43, 44,
45, 48, 50, 51, 52, 56, 63, 70, 81, 82, 84, 86, 90, 93
 arcing12, 44, 48, 50, 63, 81, 82, 91
 arc-suppression.....18, 63
 ash residue.....25
 atmospheric pressure.....56, 58, 82, 88, 97
 atmospheric pressures88, 91

B

barometric pressure56
 bifurcated contacts32
 bounce11, 12, 43, 44, 48
 bounce pattern12
 break.....12, 13, 44, 45, 57, 63, 84, 89, 96, 100, 7
 breakdown voltage16, 3
 breaks12
 bridge transfer44

C

calibrated thermostatic equipment.....50
 cam actuation42, 54, 65, 68, 95, 97
 cam follower38, 42, 65
 Canadian Standards Association81
 capacitance17
 Capacitive circuits.....48
 Carbon.....25, 86, 88
 carry5, 12, 14, 17, 24, 25, 47, 57
 cathode44, 45
 chemical25, 27, 29, 100
 chlorides.....27
 circuit parameters18, 29, 43, 44, 45
 circuit resistance.....14
 CO₂.....86
 coaxial53
 commercial contact cleaners36
 common contact5, 6, 8, 10, 74, 76
 common terminal.....5, 7
 completely released.....5
 conducted interference18

conducting path.....20, 24
 conductor3, 14, 51, 52
 cone44, 4
 contact assembly29
 contact closures12
 contact deterioration49
 contact fabrication.....29
 contact force.....10, 11, 25, 27, 29, 30,
32, 33, 41, 44, 73, 76
 contact geometry32, 44
 contact interface20, 24, 30, 44, 4, 8
 contact life.....63, 70
 contact material23, 24, 25, 27, 29, 30, 31,
32, 33, 35, 44, 45, 50, 63, 100, 5
 contact material migration.....44
 contact movement32
 contact resistance20, 24, 32, 33
 contact transit time11, 12
 contact wear29
 contact welding39, 49, 65, 91
 contacts weld.....43
 contamination.....25, 29, 32, 36, 68, 69, 70, 82, 85, 86
 continuity, electrical.....5, 10, 24, 25, 30, 33, 35, 4
 corrosion4, 50, 79
 corrosive effects70
 crater44
 crossed-cylinder32
 current1, 5, 12, 14, 16, 17, 20, 23, 24, 26,
29, 30, 33, 34, 35, 36, 38, 40, 41, 42, 43, 44,
45, 46, 47, 48, 49, 50, 56, 57, 60, 63, 64, 65,
82, 84, 86, 89, 90, 93, 95, 3

D

DC resistive circuit48, 50
 decibels79
 Department of Defense81
 dielectric breakdown63, 64, 86, 91
 dielectric strength.....16, 17, 50, 84, 89, 3
 differential expansion.....95, 97
 differential force.....6
 differential travel.....6, 8, 10, 37, 38, 39, 40, 41, 43, 4
 dimensional stability42
 diode63, 82
 double-break13
 double-pole4, 12
 double-throw1, 4, 12
 drift43
 dynamic effects55

E

elastic deformation.....11
 elastic modulus.....56
 elastic properties57, 78

electrical circuit 14, 35
 electrical discharge 17, 100
 electrical life 45
 electrical load 12, 32, 37, 38, 39, 40, 41,
 43, 45, 46, 47, 54, 56, 68, 81, 84, 91, 3, 4
 electrical polarity 45
 electrical potential 16
 electrical resistance 10, 14
 electrode 14
 electron avalanching 44
 electroplating 27
 end-use equipment 17, 42
 environment 17, 27, 30, 32, 35, 43, 56, 60,
 68, 70, 79, 84, 86, 91, 93, 99, 3, 4, 7
 erosion 39, 45, 48, 50, 63
 explosion 4, 70, 81, 84
 explosive environments 81

F

failure 43, 45, 50, 51, 52, 57, 58,
 59, 60, 69, 70, 88, 93, 3, 4
 failure criterion 43
 failure mode 45
 fatigue 37, 45, 66, 82
 flame-arresting 81
 flammable gas 81
 flux 19, 25, 29, 36
 flux residue 25
 force 4, 6, 7, 8, 9, 10, 11, 18, 19,
 25, 27, 29, 30, 32, 33, 36, 38, 41, 42, 43,
 44, 48, 52, 54, 57, 60, 65, 68, 73, 74, 76,
 82, 87, 95, 3, 4, 5, 6
 force differential 6, 10
 force-sensitive device 6
 free position 5, 6, 7, 10, 20, 6, 8
 frequency 17, 18, 43, 52, 55, 56, 58, 60, 61, 65, 75, 76
 friction 26, 73
 full overtravel 6, 10, 46, 54, 65, 3, 5, 8
 Fungus 73, 82

G

gold 23, 27, 29, 30, 32
 gold plate 27, 30
 grounding 64

H

H₂S 27, 29, 32
 heating effect 49
 Hermetically sealed 18
 high current circuits 24
 high temperature 5, 20, 41, 42, 56, 80, 93, 95, 97
 high-intensity sound 79
 humidity 30, 41, 42, 58, 68, 70, 81, 82
 hydraulic fluid 84
 hydrolysis 82

I

I²R heating 24, 26, 49, 86
 ice 70, 82, 84, 97
 ignition energy 81
 immersion 84, 86
 inductive characteristics 30
 inrush current 48, 63
 instability 38, 3
 insulated, electrical 2, 5, 12
 insulation resistance 15, 16, 17, 43, 45, 50, 56, 93
 insulator 14, 16, 45, 50, 65, 79, 89
 internal corrosion 50
 ionization 44

K

kinetic energy 11

L

leaf springs 38
 leakage current 45, 82, 86, 95, 3
 levers 38
 life distribution curve 58
 linear function 7
 linkages 2, 4, 38
 liquefied 12
 liquid splash 84
 load resistance 21, 23, 24, 35
 localized heating 44
 low current circuits 24
 low temperature 84, 95, 97
 lubrication 29, 65, 68

M

magnetic forces 12
 magnitude 1, 14, 20, 57, 60, 73, 74, 76, 78, 100, 8
 make 2, 12, 20, 29, 30, 44, 57, 78, 80
 malfunction 30, 58, 69, 74
 mating contact 44, 100, 4
 measured resistance 33
 mechanical energy 8
 mechanical forces 30, 35
 mechanical life 45, 54, 81, 91, 95
 mechanical stop 54
 melting 23, 24
 metal vapor 27, 44, 100
 metallic vapor 12
 migration 44, 50, 63
 minimum electrical ratings 48
 molten metal 43, 44, 48, 86
 mound 44, 4

N

National Electrical Code 81, 88
 National Electrical Manufacturer's Association 1, 6
 National Fire Protection Association 81

nickel barrier30
 nitrates27, 84
 nitric acid50, 82
 no-load39, 40
 normally closed circuit5, 6, 40, 41, 42, 100, 4
 normally closed contact5, 6, 10
 normally open circuit5, 6, 39, 40, 41, 42, 100, 4
 normally open terminal5, 7

O

one pole46
 open snap-acting switch14
 operating characteristics2, 3, 6, 37, 38,
42, 82, 86, 97, 100
 operating force6, 7, 38, 3, 4
 operating point5, 6, 7, 8, 9, 10, 20, 39,
40, 42, 43, 54, 73, 100, 3, 4, 5, 6, 7
 operating points41
 organic25, 27, 30, 32, 81, 82, 84, 93, 5
 overheating38
 overtravel6, 8, 10, 38, 46, 54, 65, 68, 3, 4, 5, 8
 oxidation82, 84
 oxides27, 30, 50, 82

P

parallel redundancy33
 performance requirements41, 56, 57, 78
 phenolic86
 plasma1, 44
 platinum group32
 plunger1, 2, 5, 6, 7, 8, 9, 10, 11,
12, 13, 20, 34, 35, 36, 38, 41, 42, 43,
46, 52, 54, 56, 65, 66, 68, 69, 73, 76,
77, 83, 86, 91, 93, 95, 97, 100, 3, 4, 5, 6, 7, 8
 plunger velocity12
 pole12
 polymer formation30
 polymers27, 30, 32, 100
 potential energy11
 precision snap-acting switch1, 4, 5, 7, 14, 37, 6
 premature failure70
 pretravel5, 6
 prevailing pressure91

Q

quantitative estimates62

R

Radiated interference18
 radiation18, 91, 93
 radio frequency interference17
 rebound43, 48
 release force6, 3, 4
 release point6, 8, 10, 37, 38, 41, 42, 100, 3, 6, 7
 release points6, 10, 37, 38, 39, 40, 41, 42
 release travel6, 54, 57, 6

reproducible57, 84
 RFI17, 18
 roller-lever54
 roller-plunger54

S

sea level86, 88, 89, 90, 91
 sealed switch32, 56, 81, 86, 91, 95, 97
 settling-in37
 shift37, 38, 39, 41
 shock10, 37, 42, 54, 73, 74, 75, 76, 77, 78, 79, 97, 6
 short circuit49, 50, 51, 52, 79
 side thrust38, 69, 95, 97
 silicon27, 6
 silicone27, 29, 6
 silver contacts27, 29, 30, 32, 44, 82
 silver sulfide27, 30
 single phase52
 single-break13
 single-pole12
 snap-action5, 6, 88
 snapover8
 softening23, 24, 35
 solder flux19
 soldering25, 29, 36, 38, 42
 solenoid coils49
 solvents25, 36
 source voltage21, 24, 33, 50, 63
 spring life63, 66
 stabilization period37
 static equilibrium12
 statistical estimates12, 69
 steady-state47, 48, 49, 50, 63
 stored energy2, 8
 sulfides27, 30, 32, 82
 switch design12, 18, 32, 43, 78, 93
 switch life38, 43, 45, 47, 50, 52, 54, 56,
58, 60, 62, 63, 64, 65, 66, 68, 69, 95, 3
 switch mechanism2, 6, 8, 18, 20, 27, 41, 44,
48, 50, 55, 63, 65, 76, 78, 82, 94
 switch resistance18, 19, 20, 21, 23, 24, 25,
29, 30, 32, 33, 34, 35, 36, 48, 93

T

tarnish film30
 tarnishing27, 30
 terminal insulators18
 terminal, common5, 13, 34, 100, 4, 7
 testing17, 56, 57, 58, 62, 68, 93
 thermal12, 29, 97, 4, 8
 throw12
 time delay49
 time scale38
 torque41, 4
 total resistance20, 24
 total travel6

General Technical Bulletin #14 - Applying Precision Switches

transfer time.....	52
transit time.....	11, 12
travel characteristics	6

U

U. S. Bureau of Mines	81
Underwriters' Laboratories.....	49, 81, 88
unsealed switches	36, 68, 82, 84, 86, 89, 91, 97

V

vacuum	56, 63, 68, 70, 71, 88, 89, 90, 91
velocity	12, 52, 54, 65, 66, 73, 74, 76, 97, 100, 6
vertical scale.....	38, 40
vibration	1, 10, 12, 42, 73, 76, 77, 78, 79
voltage	2, 4, 14, 16, 17, 21, 23, 24, 29, 30, 33, 34, 35, 36, 45, 46, 48, 50, 52, 60, 63, 64, 85, 89, 91, 93, 3
voltage drop.....	34
voltage transient	50

W

water vapor.....	27, 50
Weibull parameters.....	60
wiring conduit.....	86

WARRANTY/REMEDY

Honeywell warrants goods of its manufacture as being free of defective materials and faulty workmanship. Contact your local sales office for warranty information. If warranted goods are returned to Honeywell during the period of coverage, Honeywell will repair or replace without charge those items it finds defective. The foregoing is Buyer's sole remedy and is **in lieu of all other warranties, expressed or implied, including those of merchantability and fitness for a particular purpose.**

Specifications may change without notice. The information we supply is believed to be accurate and reliable as of this printing. However, we assume no responsibility for its use.

While we provide application assistance personally, through our literature and the Honeywell web site, it is up to the customer to determine the suitability of the product in the application.

For application assistance, current specifications, pricing or name of the nearest Authorized Distributor, contact a nearby sales office. Or call:

1-800-537-6945 USA

1-800-737-3360 Canada

1-815-235-6847 International

FAX

1-815-235-6545 USA

INTERNET

www.honeywell.com/sensing

info@micro.honeywell.com

Honeywell

MICRO SWITCH
Sensing and Control
Honeywell Inc.
11 West Spring Street
Freeport, Illinois 61032



Printed with Soy Ink
on 50% Recycled Paper



European Photoelectric Centre
Honeywell-Cométa
21 Chemin du Vieux Chêne
38243 Meylan Cedex
France
Tel (33) 76 41 72 00