

## Installation Instructions for the AWM5000 Series Microbridge Mass Airflow Sensor

ISSUE 3

PK 88762

### GENERAL INFORMATION

AWM5000 Series Microbridge Mass Airflow Sensors operate on the theory that airflow directed across the surface of a sensing element causes heat transfer. Output voltage varies in proportion to the mass of air or other gas flowing through a given sensor's inlet and outlet ports.

**Current sink/source.** Maximum current ratings are 10 mA sinking and 20 mA sourcing, governed by an LM224 operational amplifier in the final stage of the instrumentation amplifier.

### MEDIA CONTAMINATION

Media flowing through the sensor should be free of condensing moisture and particulate contaminants. An inexpensive 5 micron filter upstream of the sensing element substantially reduces the risk of damage due to contaminants.

### MOUNTING INSTRUCTIONS

Mount AWM5000 Series sensors with 6-32 screws. Use of washers below screw head is recommended. Mounting torque is 1.1 Nm (9.75 in/lb) max. for steel screws, or 0.75 Nm (6.75 in/lb) max. for brass screws.

#### NOTICE

When making flow connections to mounted sensor, the AWM5000 **must** be supported at the flow adapter.

If end adapters are twisted with respect to the flow tube during installation, the seal between O-ring and flowtube will be broken, causing a small temporary leak. The leak can be as high as 1 psi, or may remain within specification. It will self-heal as the O-ring conforms. About 85% of the leak will be gone in 24 hours, with complete recovery within 48 hours.

Do not expose ports to forces greater than 1 kg [2 pounds] in a direction perpendicular to the port centerline.

Torque on ports should not exceed 4,52 Nm [40 in/lb].

### ELECTRICAL CONNECTION

The AWM5000 Series accepts a latch detente connector, such as:

1. Amp part number 103956-3,
2. Sensing and Control part number SS-12143.

Information and literature on latch detente connector is available from Amp Product Information Center, 1-800-522-6752 or the Customer Hotline, 1-800-722-1111.

### RECOMMENDED AMP LITERATURE

82160	MTE Interconnection System (AMPMODU) Catalog
108-25034	Product Specification (technical performance information)
114-25026	Application Specification (describes product, proper assembly, full tooling information)
IS 6919	Instruction Sheet for assembly procedure

### TO MAKE ELECTRICAL CONNECTIONS

1. Remove (unlatch) the connector from the AWM5000.
2. Hand-crimp the interface wire to the appropriate pin on connector. Suggested tool: AMP Hand-Crimp Tool, part number IS9407.
3. Insert the terminal contacts into the connector housing after carrier strip (lead-frame) is removed.
4. Reconnect (latch) connector to AWM5000 device.

### CLEANING

#### NOTICE

Do not use ultrasonics when cleaning. This may damage the microstructure.

Cover the ends of the tube during cleaning, since certain solvents may attack the epoxy which seals the chip tube to the ceramic substrate. Do not use: III Tri-chloroethane, methylene chloride, methyl pyrrolidone, or any oxidizing type acid such as formic acid.

## SPECIFICATIONS

Recommended power supply (1)	10 ±0.01 Vdc
Minimum power supply	8.0 Vdc
Maximum power supply	15.0 Vdc
Power consumption	100 mW max.
Output type	Linear, 1.0 Vdc to 5.0 Vdc
Calibration gas	Suffix VA = Argon VC = CO <sub>2</sub> Carbon Dioxide, N <sub>2</sub> O Nitrous Oxide VN = N <sub>2</sub> Nitrogen, O <sub>2</sub> Oxygen, Air
Gas flow range	AWM5101 0 to 5 SLM (5) AWM5102 0 to 10 SLM AWM5103 0 to 15 SLM AWM5104 0 to 20 SLM
Output at laser trim point	5.0 Vdc at Full Scale Flow
Differential pressure at full scale	See Pressure vs Flow Chart
Null output	1.00 ±0.05 Vdc
Null output shift, -20 °C to 70 °C	± .050 Vdc typ., ± .200 Vdc max.
Full scale output shift, -20 °C to 25 °C and 25 °C to 70 °C (4)	Suffix VA or VN: ±7.0% F.S.O. Suffix VC: ±10.0% F.S.O.
Linearity error (2)	± 3.0% reading
Repeatability & hysteresis	± 0.5% Reading
Response time	60.0 msec max.
Temperature range, operating and storage	-20 °C to 70 °C [-4 °F to 158 °F]
Termination (0.100 in centers)	0.025 in square
Connector (4 pin receptacle), included (3)	AMP (103956-3)
Weight	60 grams [2.06 oz.]
Shock rating	100 g peak, 6 msec half-sine (3 drops, each direction of 3 axes)
Vibration rating	15 g, 10 Hz -2000 Hz -10 Hz
Overpressure	50 psi max.
Leak rate, max.	0.1 psi/min. at static condition

1. Cannot guarantee calibration at supply voltages other than 10.0 ±0.01 Vdc.
2. Linearity specification applies from 2 % to 100% full scale of gas flow range and does not apply to null output at 0 SLM.
3. Supplied in strip form. Other strip form receptacles are available as are various tools to assemble receptacles in strip form. Individual receptacle assemblies are also available from Amp.
4. SLM sensors have larger Full scale shifts over temperature. 0-20 SLM sensors have lowest shifts with respect to temperature.
5. SLM denotes standard liters per minute which is a flow measurement referenced to standard conditions of 0 °C, 760 torr (sea level), 50% RH.

## CHARACTERISTICS

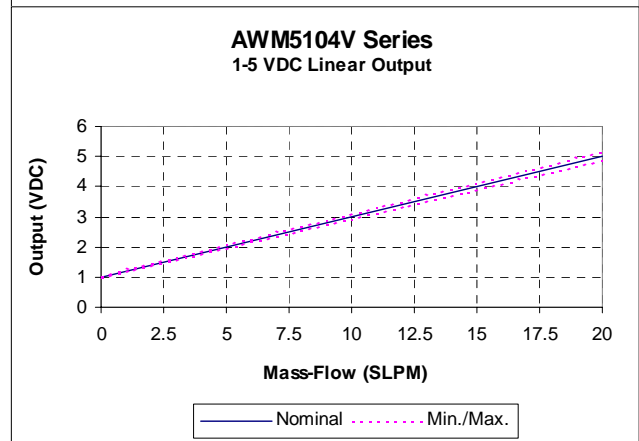
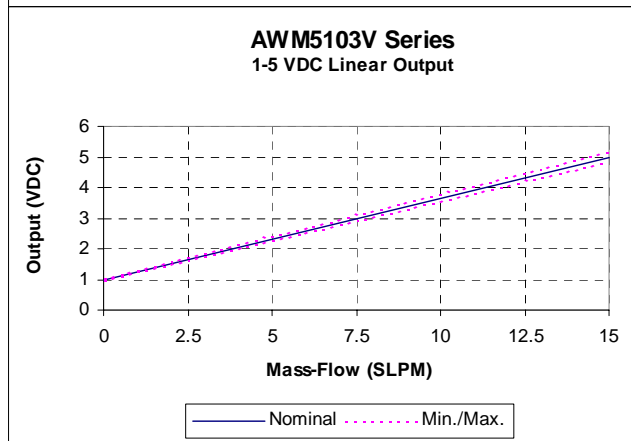
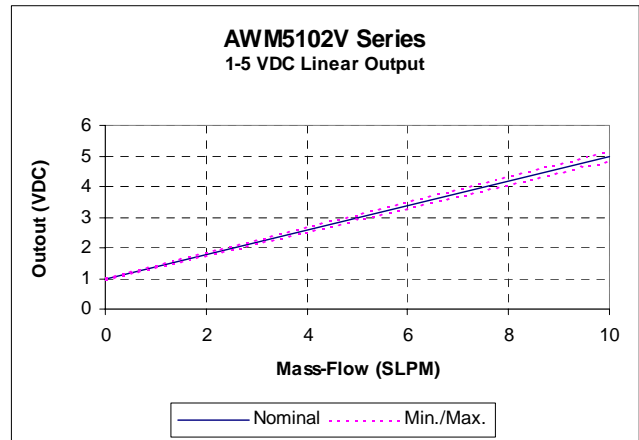
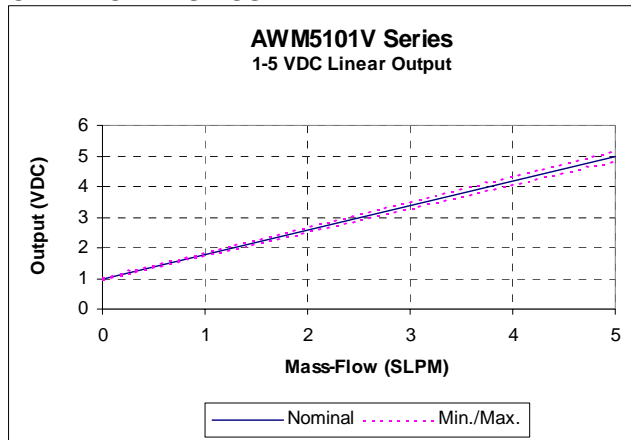

## PRESSURE vs. AIRFLOW

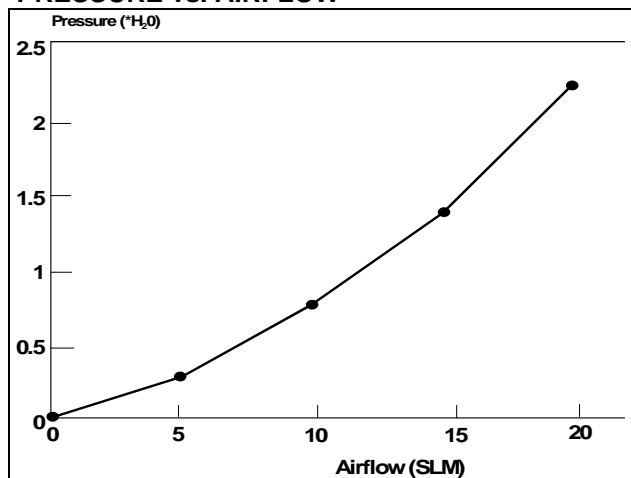

## PRODUCT DESCRIPTION

Catalog Listing	Flow Range
AWM5101VA	5 SLPM, Argon calibration
AWM5101VC	5 SLPM, CO <sub>2</sub> calibration
AWM5101VN	5 SLPM, N <sub>2</sub> calibration
AWM5102VA	10 SLPM, Argon calibration
AWM5102VC	10 SLPM, CO <sub>2</sub> calibration
AWM5102VN	10 SLPM, N <sub>2</sub> calibration
AWM5103VA	15 SLPM, Argon calibration
AWM5103VC	15 SLPM, CO <sub>2</sub> calibration
AWM5103VN	15 SLPM, N <sub>2</sub> calibration
AWM5104VA	20 SLPM, Argon calibration
AWM5104VC	20 SLPM, CO <sub>2</sub> calibration
AWM5104VN	20 SLPM, N <sub>2</sub> calibration

All listings have 1 Vdc - 5 Vdc linear output with 10 Vdc supply over given flow range for a given gas.

## MOUNTING DIMENSIONS (for reference only) mm/in

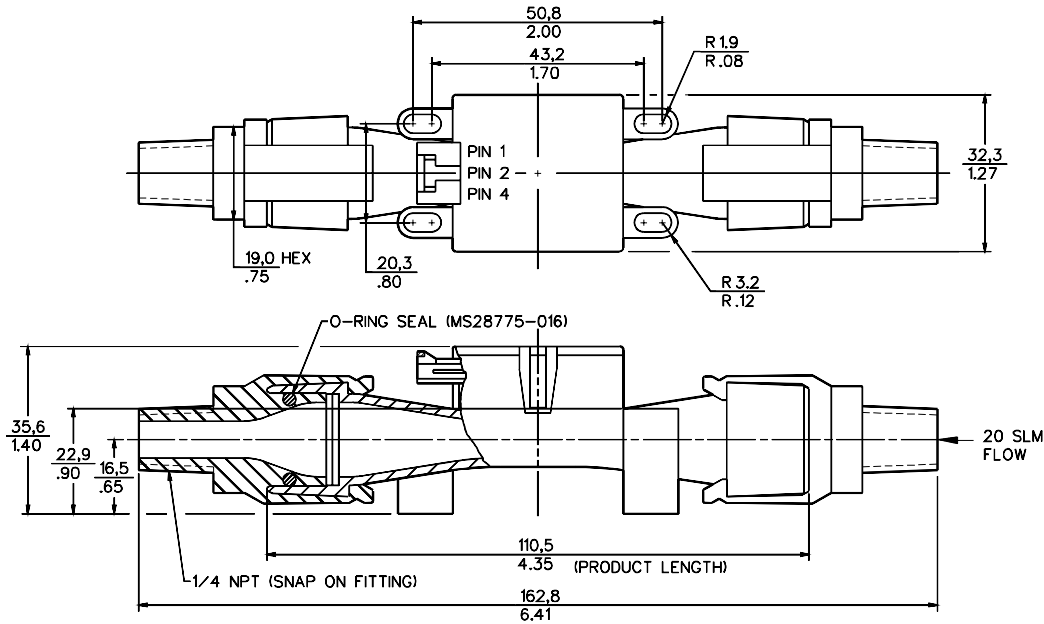

## OUTPUT CONNECTIONS

Pin 1	+ Supply voltage
Pin 2	Ground
Pin 3	No connection
Pin 4	Output voltage

**Note:** Flow direction is marked on housing.

## SS-12143 CONNECTOR

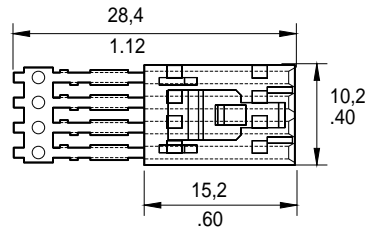

## WARRANTY/REMEDY

Honeywell warrants goods of its manufacture as being free of defective materials and faulty workmanship. Contact your local sales office for warranty information. If warranted goods are returned to Honeywell during the period of coverage, Honeywell will repair or replace without charge those items it finds defective. The foregoing is Buyer's sole remedy and is **in lieu of all other warranties, expressed or implied, including those of merchantability and fitness for a particular purpose.**

Specifications may change without notice. The information we supply is believed to be accurate and reliable as of this printing. However, we assume no responsibility for its use.

While we provide application assistance personally, through our literature and the Honeywell web site, it is up to the customer to determine the suitability of the product in the application.

For application assistance, current specifications, or name of the nearest Authorized Distributor, contact a nearby sales office. Or call:

1-800-537-6945 USA  
 1-800-737-3360 Canada  
 1-815-235-6847 International

### FAX

1-815-235-6545 USA

### INTERNET

[www.honeywell.com/sensing](http://www.honeywell.com/sensing)  
[info.sc@honeywell.com](mailto:info.sc@honeywell.com)

# Honeywell